



ZONE^{RV}

SOJOURN & PEREGRINE GENERATION 2



FOREWORD

This document is applicable to the **2024 GEN2** model equipped with the REDARC™ Multi ROGUE™ power distribution and MANAGER ALPHA 100 charging systems.

Significant improvements have been made to enhance the owner experience including:

- Battery charging
- Power saving
- Lighting control and dimming
- Water control
- Pop-Top control
- System control

CONTENTS

CRUISEMASTER TOW HITCH		REDARCDIGITALMANAGEMENT SYSTEM	14	MOBILEINTERNET	29
CRUISEMASTER DO35	1	REDVISIONMOBILEAPP	15-16	REFRIGERATOR	30-31
CRUISEMASTER DO45	1			SYSTEM OPERATIONAL CHART	32
COUPLING	1	REDARC BATTERY CHARGER		ELECTRICAL SYSTEM DIAGRAMS	
DECOUPLING	2	REDARCBATTERYCHARGER	17-18	REDARCBATTERYCHARGER	33
HANDBRAKE ADJUSTMENT	2	BATTERY CHARGE SETTINGS	19	12VDCSYSTEMLINEDIAGRAM	34
TRAILER PLUG CONFIGURATION		CAR ANDERSON CHARGE SETTING	20	ELECTRICAL SPECIFICATIONS	
7PINTOWPLUG	3	NIGHT MODE SETTING	21	FUSE RATINGS	35
ANDERSON PLUG	4	REDARC INVERTER	22	FUSE LOCATIONS	36
GASSYSTEM	6	LIGHTING		PLUMBING SYSTEM	
SMOKE SENSOR	6	TOWINGCLEARANCEAND SIGNAL LIGHTING	23	WATERTANKCOUPLING LAYOUT-WITHSINGLEPUMP	37
CARBON MONOXIDE SENSOR	7	STORAGE LIGHTING	22	WATERTANKCOUPLING LAYOUT-WITHISOLATEDDRINK PUMP	38
ELECTRICAL SYSTEMS		EXTERIOR LIGHTING	23	FILLINGWATERTANKS	39
ELECTRICAL CERTIFICATE	8	INTERIOR LIGHTING	24	DRAININGWATERTANKS	39
240V AC POWER SYSTEM	8	ENTRANCE AIR BAG PANEL	25	GREYWATERBYPASS	40
240V AC POWER SYSTEM	8	WATER CONTROL	26-27	TOILETSYSTEM	40
12V DC POWER SYSTEM	9	VENTILATIONSYSTEM	28	REFILLINGTANKSWITH PORTABLEWATERPUMP	40
STORAGE BATTERIES	10	USB AND 12V SOCKETS	28		
DC SYSTEM ISOLATION	11	SOUND SYSTEM	28		
SYSTEM MODE	12				
ROOFTOP SOLAR PANELS	13				
PORTABLE SOLAR PANEL PORT	13				

CONTENTS

PLUMBING SYSTEM

WATER PUMP	42
WATER FILTERS	42
PLUMBING SYSTEM DIAGRAM - SINGLE PUMP	43
PLUMBING SYSTEM DIAGRAM - TWIN PUMP	44
HOT WATER SYSTEM	45-46

JOCKEY WHEEL	47
---------------------	-----------

SUSPENSION SYSTEM

ATX AIRBAG SUSPENSION (DRUM BRAKES) - STANDARD	48
ATX AIRBAG SUSPENSION (DISC BRAKES) - UPGRADE	48
SETTING RIDE HEIGHT	48
HEIGHT SETTING METHOD	48
OPERATING AT NON-STANDARD HEIGHT	49
CARAVAN STORAGE	49
"GET YOU HOME" MODE (EMERGENCIES ONLY)	49

AIRBAGS

TRAVEL HEIGHT	50
AIR BAG CONTROL PANEL - MANUAL LEVELLING SYSTEM	51
AIR BAG CONTROL PANEL - AUTOMATIC LEVELLING SYSTEM	52

MAINTENANCE

SAFE JACKING	53
DRUM BRAKE ADJUSTMENT	53-54
WHEEL HUBS	54
CHECKPOINTS AFTER A SHORT TIME ON THE DIRT	55
DUST INGRESS	55
BEACH USE	56
CARAVAN WELDING	56
DRAWER FRONT PANEL ADJUSTMENT	57

PREPARING FOR OFF-ROAD	58
-------------------------------	-----------

DRIVING RECOMMENDATIONS

STANDARD COLD TYRE PRESSURES - 110km/h SPEED LIMIT)	59
DUSTY ROAD TYRE PRESSURE - 35 PSI (100km/h SPEED LIMIT)	59
SAND DRIVING	60
WATER CROSSING	60

RECOVERY POINTS	61
BIKE CARRIER (OPTIONAL)	61

DEPARTURE CHECKLIST

INTERNAL CHECK	62
EXTERNAL CHECK	62
SAFETY CHECK	63
WHEEL NUTS/LUGS & BEARINGS	63

VIN/COMPLIANCE PLATE, TARE & ATM	64
---	-----------

ZONE RV AFTER SALES SERVICE CONTACT	65
--	-----------

DISCLAIMER	66
-------------------	-----------

AMENDMENTS	67
-------------------	-----------

OWNERS NOTES	68
---------------------	-----------

CRUISEMASTER TOW HITCH

CRUISEMASTER D035



CRUISEMASTER D045 (4000kg ATM Upgrade)



COUPLING

- The caravan should only be coupled on level ground.
- Make sure towing pin and universal is free of sand, dirt and foreign objects, and is lightly lubricated.
- Raise height of trailer coupling above vehicle towing pin by adjusting the RV jack.
- Push and hold lock button down, push the locking plate back to fully open position until the lock button springs back.
- Align coupling over towing pin by moving either vehicle or trailer, and lower.
- Ensure that the hitch is seated properly on the pin.
- Push the lock button to release the plate into the locked position.
- Assemble the dust cover by snapping in the back edge of the seal first and then pushing on the front.
- Dust cover will emit an audible snap when assembled correctly.

DECOUPLING

- Caravan should only be uncoupled on level ground.
- If uneven surface, leave the chains on until finished unhitching the caravan.
- Engage handbrake and chock wheels if required.
- Remove dust cover, tow plug, camera lead, brake-safe lanyard and safety chains.
- Push and hold lock button down, push the lock plate to fully open position until the lock button springs back.
- Lower jack leg to raise the height of trailer above vehicle towing pin.

HANDBRAKE ADJUSTMENT

The cable should be adjusted in such a way that when the handbrake is disengaged there is some slack in the cable to ensure the brakes will not be dragging during normal operation. It is recommended to adjust this so that at the highest engaged position of the handbrake, the attachment lever is vertical. A further check should be made with the suspension at both ends of its travel to ensure the brakes do not operate in the bump and rebound conditions.

Refer to the **CRUISEMASTER** website for additional information.

www.cruisemaster.com.au/cruisemaster-do35-v3plus

<https://cruisemaster.com.au/cruisemaster-do45-plus>

TRAILER PLUG CONFIGURATION

7 PIN TOW PLUG

ZONE RV caravans are equipped with the industry standard 7-pin flat connector.

The image below details all connections required between the tow vehicle and the caravan.

PIN No.	CIRCUIT	CABLE	COLOUR
1	Left-hand turn	ECA3 1.13	Yellow
2	Reversing signal		Black
3	Earth return	ECA5 3.25	White
4	Right-hand turn	ECA3 1.13	Green
5	Service brakes	ECA5 3.25	Blue
6	Stop lamps	ECA3 1.13	Red
7	Rear lamps, clearance & side marker lamps	ECA3 1.13	Brown

Cable Entry View



7 Pin Socket



7 Pin Plug

! NOTE: It is the responsibility of the Tow Vehicle driver to ensure the wiring is correct and that all lights operate prior to towing the caravan with periodic checks to ensure no faults exist such as a disconnected plug or blown lamps.



ANDERSON PLUG

LOCATION: Front of drawbar

An Anderson plug is located on the drawbar and may be connected to the tow vehicle to provide supplemental charging of the caravan batteries via the MANAGER ALPHA. It is advisable to support the lead with the trailer plug lead to minimise the chance of it from becoming disconnected from the car and preventing it from dragging on the ground.

! NOTE: Wiring of the vehicle Anderson connector is the responsibility of the Tow Vehicle owner. Power should be made available via an ignition switched relay to reduce the possibility of draining the tow vehicle battery when the ignition key is off. The DC input charging current of the MANAGER ALPHA™ is preset to 50Amps from the ZONE RV factory to match the caravan wiring size and length and suits most vehicles. It is not recommended to exceed this setting. It may need to be decreased depending on the vehicle alternator capacity, Anderson supply fuse, vehicle wiring gauge and the total length from the car to the MANAGER ALPHA™ charger.

Refer to the **REDARC BATTERY CHARGER** section of this manual for setting details.

! NOTE: Some functions of the caravan are disabled while power is supplied from the Anderson connector. This allows for maximum charge current to the caravan batteries while the ignition is ON. Refer to the section **SYSTEM OPERATIONAL CHART** for details.

GAS SYSTEM

Your ZONE RV is fitted with a reticulated LPG gas system and provision for storage of up to 2 x 4.5kg gas cylinders. There is a single gas outlet with a bayonet style fitting on the passenger side of the caravan. This system is tested by a qualified Gas Certifier & fitted with a Gas Certification Plate located inside the gas bottle storage box during manufacture. Any changes or modifications to the gas system will require recertification.

! NOTE: It is recommended that the GAS bayonet line is isolated via the yellow tap and when not in use or when an annexe is fitted.

SMOKE SENSOR

In compliance with fire regulations, a battery power smoke detector is fitted to the ceiling near the caravan entry door. The battery has a typical life of up to 10 years.

Please refer to the manufacturer's webpage for complete details.

<https://www.cavius.com.au/>

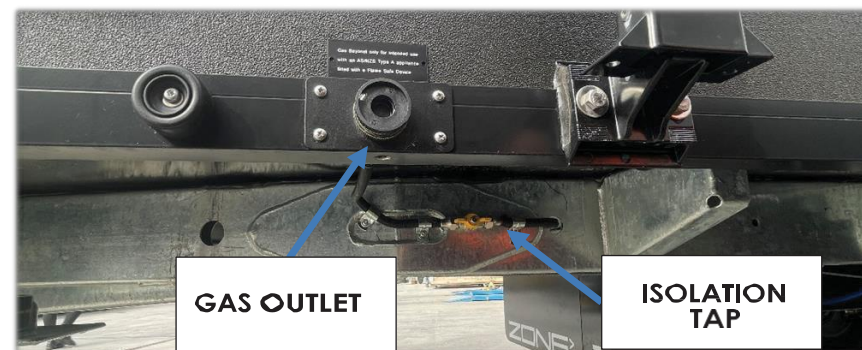

! CAUTION: LPG is a volatile fuel system and by its composition extremely explosive. Ensure great care is taken when doing anything with your gas system.



CARBON MONOXIDE SENSOR

A standalone battery powered carbon monoxide sensor is installed within the caravan. The battery has a typical lifespan of 10 years from new.

Please refer to the manufacturer's webpage for complete details.

<https://redsmokealarms.com.au/>



ZONE RV OWNERS MANUAL



ELECTRICAL SYSTEMS

ELECTRICAL CERTIFICATE

All ZONE RV caravans are supplied with a non-prescribed Electrical Safety Certificate.

Installation and testing of the 240V cabling and components are completed by a qualified Electrician. Any unauthorised changes will void the certification and 240V warranty.

⚠ CAUTION: All electrical work on the 240V AC system may only be carried out by a licensed Electrician.

240V AC POWER SYSTEM

240V power is available by connecting an approved 15Amp caravan power extension lead to the external side wall socket. The wall socket has an incorporated RCD protection switch.

Alternatively, the caravan is equipped with a 240V inverter to provide power from the storage batteries to the power sockets, Air Conditioner and Cooktop.



A good quality pure sinewave generator may be connected to the external 240V side wall socket to provide power to all 240V outlets and equipment within the caravan. Alternatively, the MANAGER ALPHA™ may be plugged into the generator, via an external RCD, to charge the batteries whilst simultaneously using the inverter for 240V power inside the caravan.

IMPORTANT INFORMATION ABOUT GENERATORS

Depending on the generator power capacity, you may need to restrict the number of appliances including the caravan Air Conditioner and Cooktop.

The MANAGER ALPHA battery charging system is connected to a 240V GPO located adjacent the battery charger which is supplied directly from the 240V wall input socket. Turn off the GPO to isolate the charging system from the generator if required.

12V DC POWER SYSTEM

The caravan is equipped with multiple storage batteries that provide power to the Lights, Fans, Fridge, Air Compressor (for suspension), USB sockets and Inverter.

The 240V inverter can draw power from the storage batteries for operation of the Air Conditioner, Cooktop and 240V appliances when mains 240V power is not connected. The 240V electrical system will automatically switch to the external 240V mains supply when power is available conserving battery charge.

Due to inverter power limitations, it is advised that the A/C unit, Cooktop and other 240V appliances are not operated concurrently when the caravan is not connected to 240V mains power supply.

 **CAUTION:** All electrical work on the 12V DC system may only be carried out by a licensed Auto Electrician.

STORAGE BATTERIES

In compliance with AS3001.2, the storage batteries are installed within a sealed durable compartment located under the caravan. The DC voltage system is protected via a high current Mega fuse located within the battery storage compartment to safeguard against high current overload or major short circuit conditions.

Additional lower amperage fuses located on the electrical panel are provided for selected systems. The ROGUE™ modules contain internal “fuse less” electronic protection devices for other circuits such as lighting.

Refer to the REDARC™ equipment manual for full details. A movable lifting platform cable of 150Kg lift capacity is required for removal and installation of the battery storage compartment.

 **CAUTION:** The battery box must only be opened by a licenced auto electrician or electrician familiar with 12V power systems.

 **CAUTION:** To minimise risk of electric shock or arcing to the grounded caravan chassis, always disconnect the NEGATIVE lead first from the battery storage compartment then disconnect the POSITIVE lead. Always reconnect the POSITIVE lead first then reconnect the NEGATIVE lead.

DC SYSTEM ISOLATION

The caravan is equipped with two low voltage isolation switches for emergency use or to perform maintenance of the 12V electrical system.

- DC Isolator switch for the storage Batteries located under the right hand side lounge seat.
- Solar Panel Isolator Circuit breaker located at the top of the electrical system power board for the caravan fixed panels and auxiliary solar port.



Isolation procedure:

- Always turn the water heater system off first via the control thermostat device located adjacent the vanity.
- Press the Solar system circuit breaker RED button, yellow lever pops out.
- Turn the DC isolation switch OFF.

The steps below must be followed if the battery compartment needs to be removed.

- Disconnect the Negative cable at the battery compartment terminal first.
- Disconnect the Positive cable at the battery compartment.
- Disconnect the signal cable at the battery compartment.

Connection of the battery compartment is the reverse of the previous steps with reconnection of Positive lead first.

- Turn the DC isolation switch ON.
- Close the Solar system circuit breaker (press in yellow lever).
- Turn the water heater on via the control thermostat.

! NOTE: It is not recommended to use the DC isolator for caravan storage.

Refer to the **SYSTEM MODE** section for long term caravan storage.

SYSTEM MODE

Select **Touring** mode for normal use of the caravan.

Select **Storage** mode when not using the caravan for extended periods and ensure that mains power is connected to the external inlet or that the caravan solar panels are positioned to accept sunlight to keep the storage batteries at optimum charge.

The Manager Alpha will continue to charge the batteries while in **Storage** mode. The system will automatically switch to **Touring** mode when the tow vehicle Anderson plug is connected and live.

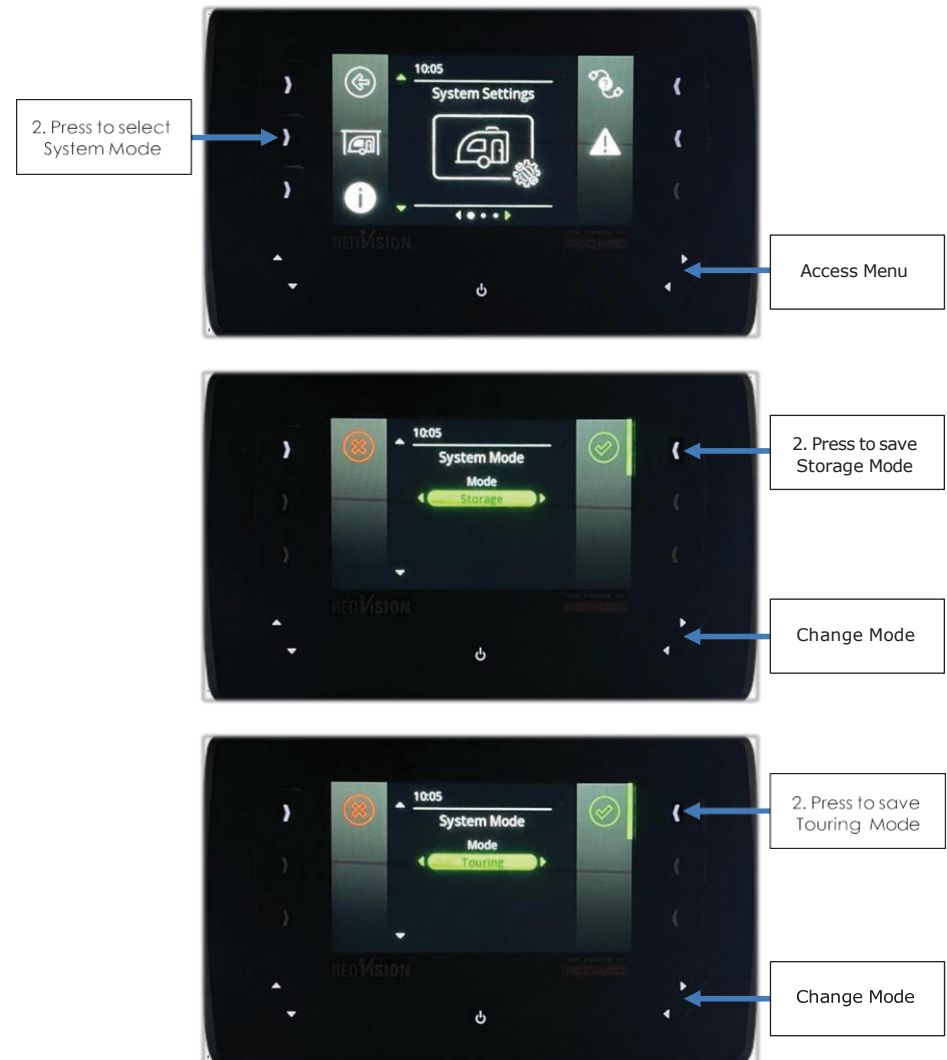

ROOFTOP SOLAR PANELS

An array of Solar panels fixed to the roof of your ZONE RV caravan provide power to charge the storage batteries via the MANAGER ALPHA charger.

All panels are connected in a parallel configuration. Each panel is protected by individual fuses which is located with the drivers' side electrical compartment.

Refer to the **Fuse Specifications** section for fuse ratings. Periodic inspection and cleaning of the panel surfaces will ensure optimum charging efficiency.

⚠ CAUTION: Do not stand or place objects on the solar panels.

⚠ CAUTION: To minimise the risk of injuries when working at heights, ensure that the appropriate safety equipment is used when cleaning the solar panels. There are no anchor points on the caravan roof that are suitable for fall arrest and restraint purposes.

PORTABLE SOLAR PANEL PORT

An external RED Anderson socket located at the underside rear of the caravan provides a connection for a portable solar panel or blanket. The socket is suitable for a solar blanket of up to 300Watts.

The socket is directly connected to the Solar Circuit Breaker located on the electrical panel and is connected in parallel with the roof top panels.

Suitable fusing of the external Solar panel is the responsibility of the caravan owner. Only attach solar panels without an internal regulator.

For best results, the solar panel maximum output voltage should closely match the caravan fixed panels which is within the range of 20 to 24V DC.



Isolation Switches for Air Conditioner and Cooktop

Your caravan is equipped with isolation switches for the air conditioner and cooktop, allowing you to safely disconnect power when needed.

Air Conditioner Isolation Switch:

Located near the unit, this switch isolates power to the air conditioner for maintenance, when not in use, or in an emergency. Turn the switch to the "OFF" position to disconnect power.

Cooktop Isolation Switch:

Located near the cooktop, this switch cuts power to the cooktop when not in use or during cleaning and maintenance. Flip the switch to "OFF" to isolate power.

Safety Note:

Always turn off isolation switches before cleaning, servicing, or leaving appliances unused to ensure safety.



REDARC DIGITAL MANAGEMENT SYSTEM

Located inside the caravan adjacent to the entrance door is the REDVISION™ control panel. It is the central point for controlling the lighting, fans, water delivery, fridge and 240V inverter.

The control panel has the capability of providing multiple overlay screens for access to each of the output controls and has been intuitively grouped for convenient access.

Refer to the REDVISION™ QuickStart Guide which can be found within the REDARC™ manuals or via the web link. [RedVision Quickstart Guide](#)

An icon adjacent to each switch on the REDVISION™ control panel illuminates GREEN to indicate that the output is ON and operating correctly.



If the system detects an overload condition for any given output, the icon will change to RED indicating a fault is present. Full details of the fault detection system can be found within the REDARC™ ROGUE™ manual.

Items that are controlled via the REDARC™ ROGUE™ control modules make use of intelligent electronic switches that do not require fuses. Dedicated fuses located on the system control panel located within the electrical service hatch provide power to equipment such as the Brakes, Trallsafe, Witi, Hot Water, Air Heater, and Awning.

! NOTE: If you are experiencing any problems with the REDVISION™ system, please refer to the product manuals or contact REDARC™ technical support. Ph (+61) 1300 733 272

REDVISION MOBILE APP

With the Redarc control system, users can download the REDVISION™ App to operate most items using Bluetooth connectivity to your caravan.

Check the App store for iPhone or Android cell phone compatibility.



Refer to the Redarc REDVISION™ users guide for full details. If difficulties are experienced when trying to pair or control your system, close the App and remove any devices labelled REDARC™ from your phones Bluetooth connection list and try to pair again.



The images below show the remote-control functions mirrored from the REDVISION™ control panel which also provide the benefit of labelling. Lights may also be dimmed by a continual press of a given touch tile.

A soft switch is provided to power up and check the GPS Odometer reading located within the electrical service hatch while the tow vehicle Anderson connector is not connected or live. It will automatically turn off within the time specified with the SYSTEM OPERATIONAL CHART.

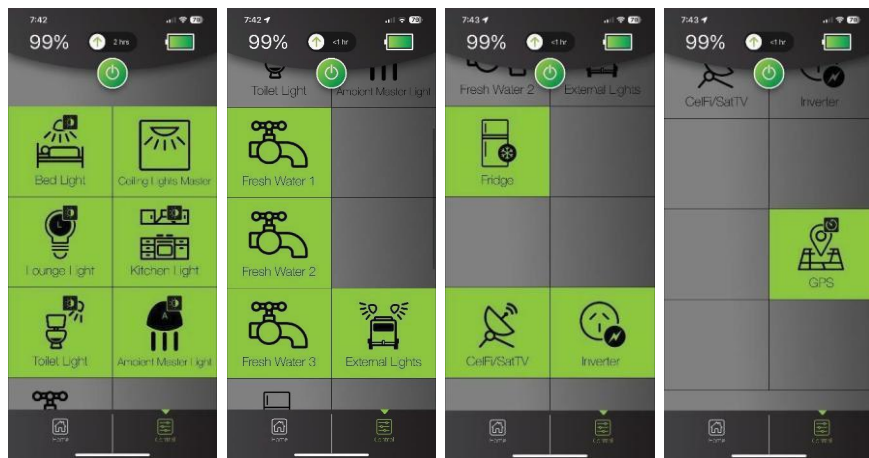

Alternate layout with optional drinking water pump.



Storage Tanks and Battery Charging Home screens.



REDARC BATTERY CHARGER

LOCATION: Inside the electrical service panel.



The charger is the heart of the caravan power system for maintaining charge of the storage batteries. It can draw current from the following sources with priority given to Solar Charging.

- Caravan Rooftop Solar and External Solar Socket
- 240V Side Wall Socket
- Tow Vehicle Anderson connector

Off-Grid power availability is governed by the quantity, charge and condition of the batteries installed. The "as new" power availability ranges from 400Ah (Amp/hour) for two batteries up to 800Ah for four batteries.

Always turn off unused electrical items to conserve battery charge while camping "Off-Grid".

Battery charging and protection parameters are preset at ZONE RV within the REDVISION™ control panel providing an accurate measurement of the battery capacity and state of charge. The battery Amp/hour setting may be altered via the REDVISION™ control panel when adding or removing batteries from the storage compartment to provide an accurate estimated level of charge and time to replenish the batteries to 100%.

Battery low charge protection is governed by the REDARC™ system. All loads including high voltage items that are powered via the 240V inverter are automatically turned off once the low charge threshold is reached. This is referred to as **Low State of Charge (LSOC)**. Rapid charging may be achieved by connecting the caravan to a 240V supply. Supplemental charging is provided via the Solar panels during good daylight hours and via the tow vehicle Anderson connector. Charging time via the Solar and the tow vehicle Anderson connector is dependent upon the delivery of electrical power from those sources.

It is not recommended to make alterations to the battery charge protection or chemistry parameters. These have been preset for optimal battery life. The Lithium storage batteries supplied by ZONE RV incorporate an internal Battery Management System (BMS) which provide additional safeguards from total depletion of charge.

The charging system and power consumption may be monitored via the REDVISION™ control panel. Press the Right Arrow of the lower right dual function key to view the system current flows and values.

The numbers and arrows display the magnitude of electrical current and direction. The Battery icon will change from Green to Red when power drawn from the batteries is greater than the charging current.



Typical Charging display via the REDVISION™

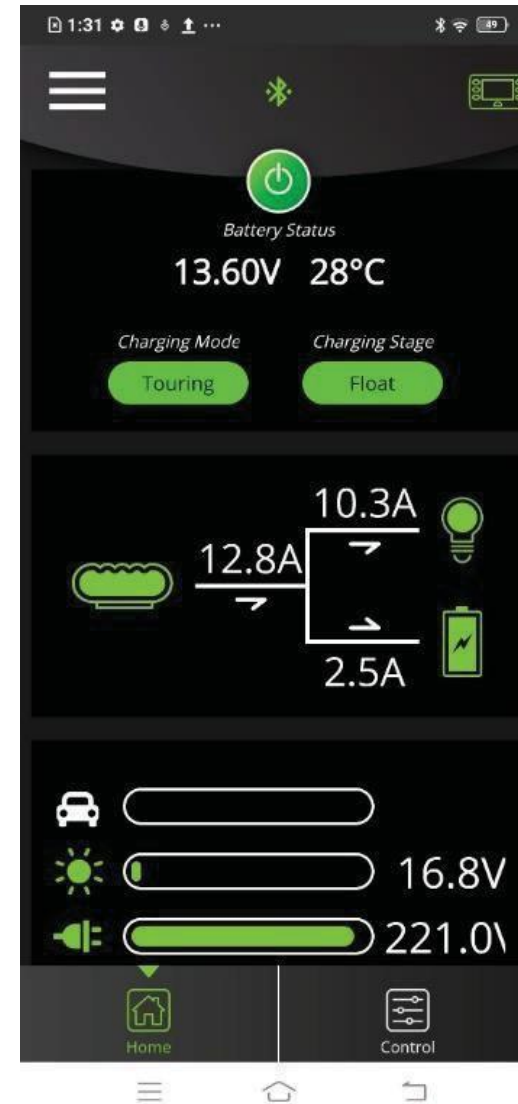

BATTERY CHARGE SETTINGS

All ZONE RV caravan battery charging systems have been preset at time of manufacture. When changing batteries, the charge settings for the MANAGER ALPHA 100 can be adjusted via the REDVISION™ control panel.

Press the left key pointing arrow on the lower right dual function key to access the settings menu then press the switch adjacent the Battery icon to enter the Charger Settings menu page.

Ensure the Chemistry is set to match the battery type which is LiFePO4 for Lithium type batteries. Set the Capacity in increments of 200Ah per battery.

For example: Set Capacity to 800Ah for four batteries.

Set the Max Charge Current according to the number of batteries installed. The recommended maximum setting for caravans equipped with one battery is 50Amps. Caravans equipped with two to four batteries may be set to 100Amps.



CAR ANDERSON CHARGE SETTING

The maximum current draw from the tow vehicle can be set within the REDVISION™ control panel BMS Settings menu. The setting is dependent on the tow vehicle electrical system reserve charging capacity and cable size.

It is possible to set the current draw from the tow vehicle to a maximum of 100Amps, however, it is not recommended to exceed 50Amps and may be required to be set lower for some vehicles.

The setting should be made in consultation with a qualified Auto Electrician who has familiarised themselves with the tow vehicle electrical system, alternator capacity and type, fusing and the wiring gauge to the Anderson connector.

Power should be made available via an ignition switched relay such as the SBI12 offered by REDARC™ to prevent draining the Tow Vehicle battery charge when the ignition key is off.

Refer to the latest user manual from the REDARC™ product webpage for complete instructions and specifications.

[Manager Alpha Instruction Manual](#)

CAUTION: Failure to correctly consider the maximum current draw may result in failure of the tow vehicle Anderson supply fuse and/or overheating or electrical fire of the wiring.



NIGHT MODE SETTING

When charging at maximum power, the MANAGER ALPHA cooling fan sound can be reduced if desired by enabling the scheduled **Night Mode** feature via the REDVISION™ control panel.

! NOTE: Enabling Night Mode may increase the charging time. Using the Left/Right and Up/Down dual function keys, navigate to the system settings page labelled CHARGER SETTINGS.

Press the key beside the crescent moon shaped icon to access the NIGHT MODE TIME settings.

Use the Left/Right and Up/Down dual function keys to enter the START and END time periods.

Press the key adjacent the GREEN tick icon to save and enable Night Mode.

Disable Night Mode by reopening the CHARGER SETTINGS and NIGHT MODE TIME pages and press the key adjacent the GREEN moon icon. The display will now show "Disabled" then press the GREEN tick key to save your selection.

Night Mode status is indicated by the crescent moon icon colour:

Green = Enabled

White = Disabled

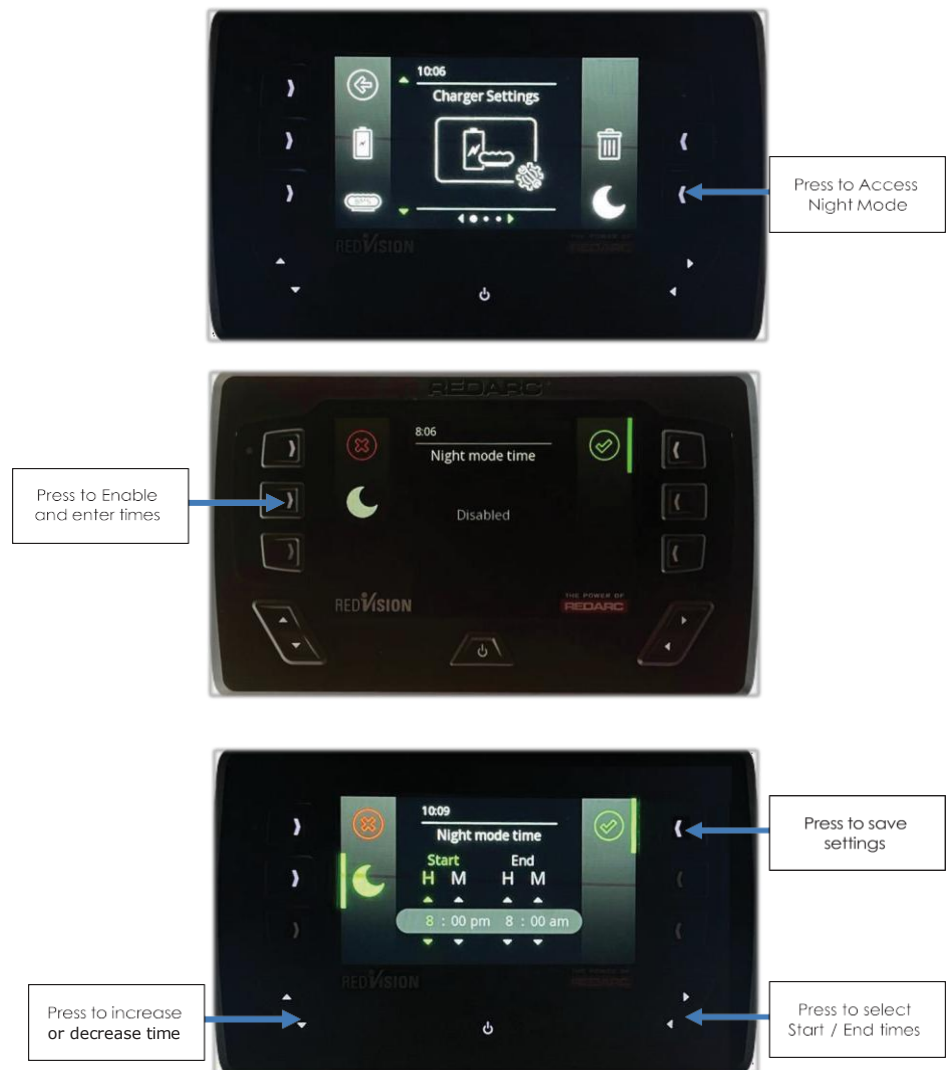

REDARC INVERTER

LOCATION: Under the right-hand side lounge seat.
Lift the seat cushion to gain access to the inverter.



The battery system supplies the inverter with 12VDC to convert to 240VAC for appliances including the Air Conditioner, cooktop, washing machine and other appliances connected to the 240V outlets. The inverter will automatically switch over to the 240V external supply socket when external mains power is detected.

Inverter capacity may not provide enough power to operate all appliances at the same time. Limit the use of 240V appliances to manage storage power availability for lighting and other electrical items.

The storage batteries will require sufficient daily recharge via the Solar system when 240V mains power is not available.

! NOTE: It is advised to turn off all 240V appliances (Air Conditioner, Cooktop) when disconnecting the external side wall 240V power lead. The appliances may then be turned on to operate from the storage batteries.

! NOTE: If replacement of the inverter is required, ensure the operating trigger wire is reinserted into the correct terminal. Using a small flat blade screwdriver, press down on the spring loaded release tab adjacent to the terminal labelled **2 ENB+** to remove or insert the bare wire conductors.

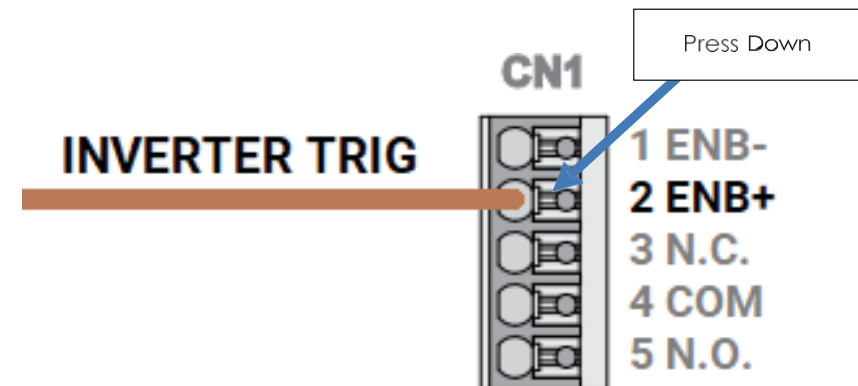

LIGHTING

TOWING CLEARANCE AND SIGNAL LIGHTING

This encompasses all exterior lighting required for highway towing such as, clearance, tail, stop and turn indicators. All lights are directly controlled by the Tow Vehicle 7 pin plug.

STORAGE LIGHTING

A dedicated switch is provided within the front storage compartment. The lights can be operated at any time to assist in packing up.

 **CAUTION:** Ensure all storage lights are turned off when not in use to minimise caravan battery drain.

EXTERIOR LIGHTING

Lights are attached to the front and rear of the caravan to provide general lighting. They can be operated via the REDVISION™ control panel or the REDVISION™ App.

A switch located on the caravan entrance air bag panel provides lighting adjacent to the entrance door. Another secondary provides selection of white or amber lighting.

External lights may be operated at anytime via the air bag panel switches or the REDVISION™ control panel or the REDVISION™ App.

 **CAUTION:** It is the responsibility of the tow vehicle driver to ensure the exterior lights are turned off when towing the caravan on public roads to comply with local laws.

INTERIOR LIGHTING

All interior and external front/rear lights may be operated via the REDVISION™ control panel located inside the caravan. Momentarily press the desired lighting zone key to turn the light on or off. Selected lighting zones incorporate a dimming function.

When a light is on, press and hold the switch to gradually reduce the brightness to the desired level. When a light is off, press and hold the switch to turn the light on then release at the desired brightness.

For convenience, a master light switch is provided on the control panel for grouped lighting control of the Bed, Lounge, kitchen and Vanity areas. It may be used to turn the lights on or off together or dim the lights in unison.

A master switch is provided to conveniently turn all roof lights on or off. The ceiling lights have a switch and internal circuitry to select Blue or White lighting.



An additional momentary action switch located on the entrance panel provides convenient access to the Ensuite light to turn on/off or dim the light.

ENTRANCE AIR BAG PANEL

All lighting zones that appear on the REDVISION™ control panel may also be operated via the REDVISION™ App.

To preserve power from the tow vehicle, some light functions are disabled while the vehicle Anderson plug is connected, and the ignition is turned on.

Refer to the section titled:

SYSTEM OPERATIONAL CHART.

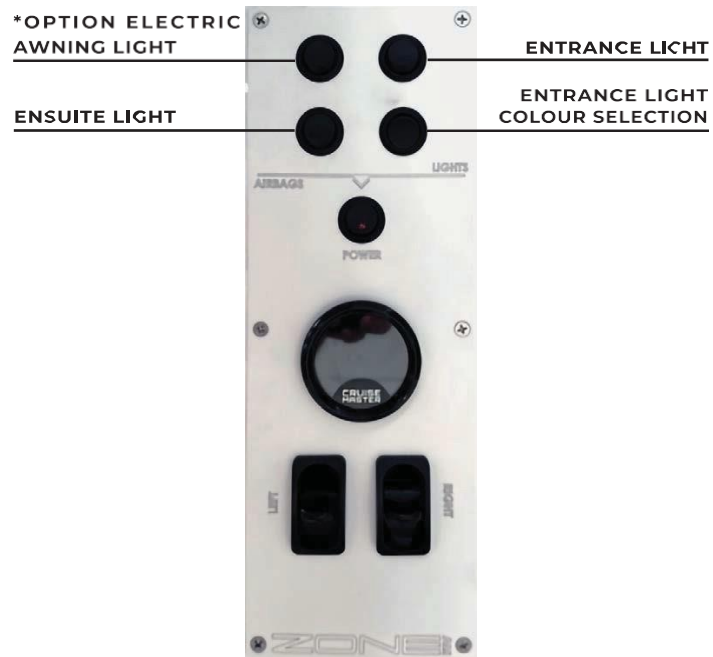

WATER CONTROL

The water delivery system comprises of one or two pumps and three tanks. Fresh water selection can be made via the REDVISION™ control panel from either Tank 1, 2 or 3 via electrically operated valves for general water use such as washing and showering. Water for the optional washing machine may be isolated via the manual tap located under the vanity.

Caravans equipped with the optional drinking tap have a separate water pump to draw water from the second tank while the main water pump provides fresh water from either Tank 1 or 3 for general use such as washing.

It is recommended to turn OFF all water delivery systems when not in use.

It is not necessary to operate the Fresh water pump when mains pressure water is connected.

STANDARD ONE PUMP SYSTEM



WITH OPTIONAL DRINKING WATER PUMP

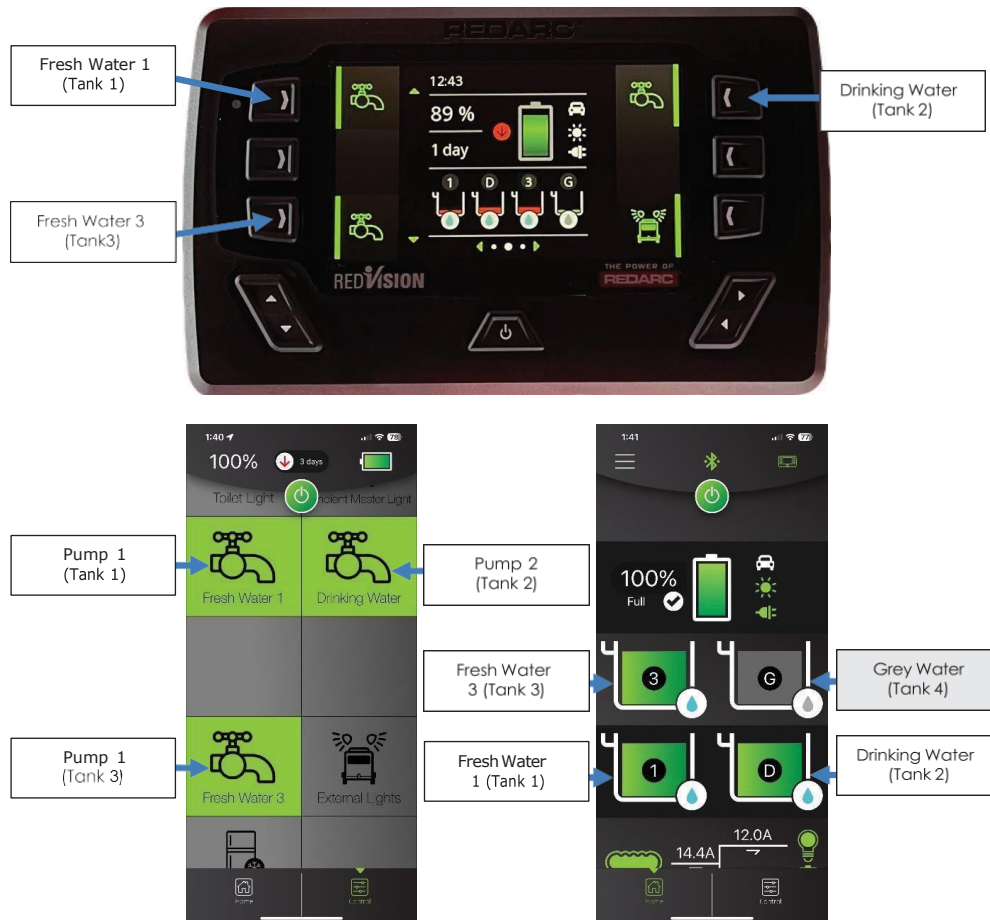

Location of Water Solenoid Valves, Pump 1 and filter under vanity.



VENTILATION SYSTEM

Two low noise fans located above the bed provide air movement within the caravan.

They each have dedicated switch controls located on the fan base.

SOUND SYSTEM

Your caravan is equipped with a professional audio sound system which may also connect to your portable devices via Bluetooth.

Power is supplied via the Redarc management system and operation is determined by the section **SYSTEM OPERATIONAL CHART**.

USB AND 12V SOCKETS

Many USB and 12V sockets have been placed throughout the caravan.

It is advised to minimise the number of connected devices due to the shared fuse limitation.

The USB-A / C combination sockets have an integrated on/off button adjacent the sockets. The socket will illuminate BLUE when power is available.



MOBILE INTERNET

Your ZONE RV caravans come standard with a wall mounted RJ45 socket to provide a weatherproof data connection point from under the lounge to the outside of the caravan.

A weather protected RJ45 Ethernet socket is located on the driver's side wall of the caravan.

This socket provides a sealed passthrough connection for equipment requiring an RJ45 type plug inside and outside the caravan. Internal access to the socket is from under the lounge where your communication equipment can be placed.

This socket may also be used for mobile internet solutions such as STARLINK™.

! **NOTE:** STARLINK make use of a proprietary connector which is not mechanically compatible with the industry standard RJ45 socket. You will need to seek the services from a qualified technician to modify your STARLINK lead to be able to utilise this socket. Any other equipment that conforms to the RJ45 standard will plug directly into the socket.

A **GUIDE** is available on the ZONE RV knowledge base for further information.



REFRIGERATOR

The fridge is 12VDC powered via a REDARC™ ROGUE™ module.

A Dedicated switch is provided on the RedVision™ control panel to remotely turn the fridge ON (GREEN indicator) or OFF (Grey Indicator). The indicator can also show electrical faults such as overload by turning RED and displaying an error message on the RedVision™ control panel.

The fridge remains powered at all times when selected with exception to the situations as listed in the section **SYSTEM OPERATIONAL CHART**.

! **NOTE:** The fridge has its own dedicated control circuitry to turn the fridge on/off, set the cooling temperature and thermal protection.

GENERAL MAINTENANCE & TIPS

CLEANING:

Wash the inside of the fridge with warm water and a mild soapy solution. Never use abrasive or corrosive cleaning agents, steel wool or scouring sponges. A soft sponge, towel, or soft brush is recommended.

Always keep the inside of the fridge clean and dry. Remove any condensate build up or ice which may gather in or around the tray under the freezer compartment.

Periodically check and remove any build up of ice around the freezer door.

Keep the doors of the fridge ajar when the fridge is not in use, to allow fresh air to circulate within the fridge compartment.

DEFROSTING

Do not allow an ice layer build up of more than approximately 5mm. Turn the fridge power off and move your food and beverages to another cool place. Do not use any objects to remove the ice or frost, it must be allowed to melt naturally. Once the ice has melted, dry the inside of the fridge and freezer compartment thoroughly.

Energy Saving Tips:

- Ensure the fridge front ventilation grill is not obstructed.
- Keep the fridge out of direct sunlight whenever possible.
- Minimise opening duration of the fridge or freezer.
- Allow hot food to cool down before placing inside the fridge.
- Minimise frost and ice buildup.
- Set the cooling level as specified on the food packaging.



SYSTEM OPERATIONAL CHART

This chart lists the states in which the various output controls are ✓ available.

- ✓1 – Switch controls are located on the appliance.
- ✓2 – Touch panel switch provided for checking the odometer reading. Active for 15mins.

System	Separate Fused Power	Control Panel Switch	Remote Switch	Dimming	Control by Timer	RedVision Panel Master Switch	Car Ignition ON (Anderson Live)	Low State of Charge
Lighting - Interior Roof		6	6 ¹			6		OFF
Lighting - Kitchen (Overhead Cupboard)		6		6		6		OFF
Lighting - Vanity (Overhead Cupboard)		6	6	6		6		OFF
Lighting - Bed (Overhead Cupboard)		6		6		6		OFF
Lighting - Lounge (Overhead Cupboard)		6		6		6		OFF
Lighting - Shower (Integrated Fan Switch)			6 ¹					OFF
Lighting - Bed (Reading Lights)			6 ¹			6		OFF
Lighting - Washing OH (Family van only)		6				6		OFF
Lighting - Bunks (Family van only)			6 ¹			6		OFF
Lighting - Side Entrance (Dual Colour)			6					OFF
Lighting - External Front and Rear		6						OFF
Lighting - Tunnel Storage			6					OFF
Roof Exhaust Fan			6 ¹					OFF
Interior Fans (On Overhead Cupboards)			6 ¹			6		OFF
Bunk Fans & Reading Lights (Family van only)			6 ¹			6		OFF
Fridge		6						OFF
Fresh Water Pump and Tank Selection		6				6		OFF
Drinking Water Pump (Option)		6				6		OFF
Toilet System								OFF
Radio		6				6		OFF
CellFi / SatTV Antenna		6				6		OFF
240V Inverter	6	6				6		OFF
Air Bag Suspension Height Adjustment	6		6					OFF
GPS Odometer	6	6 ²					ON	OFF
Electric Awning with Lighting (Option)	6		6					N/A
Electric Brakes	6	N/A				N/A	N/A	N/A
Trailsafe	6	N/A				N/A	N/A	N/A
Witi (Option)	6	N/A				N/A	N/A	N/A
Hot Water	6	N/A				N/A	N/A	N/A
Heater	6	N/A				N/A	N/A	N/A
USB 12V and TV power sockets	6	N/A				N/A	N/A	N/A

ELECTRICAL SYSTEM DIAGRAMS

240V SYSTEM LINE DIAGRAM

The inverter incorporates an internal switch-over mechanism that will automatically redirect the 240V mains input to the output when live.

When 240V mains is not available, the inverter can be manually turned on or off via the Revision Touch Panel.

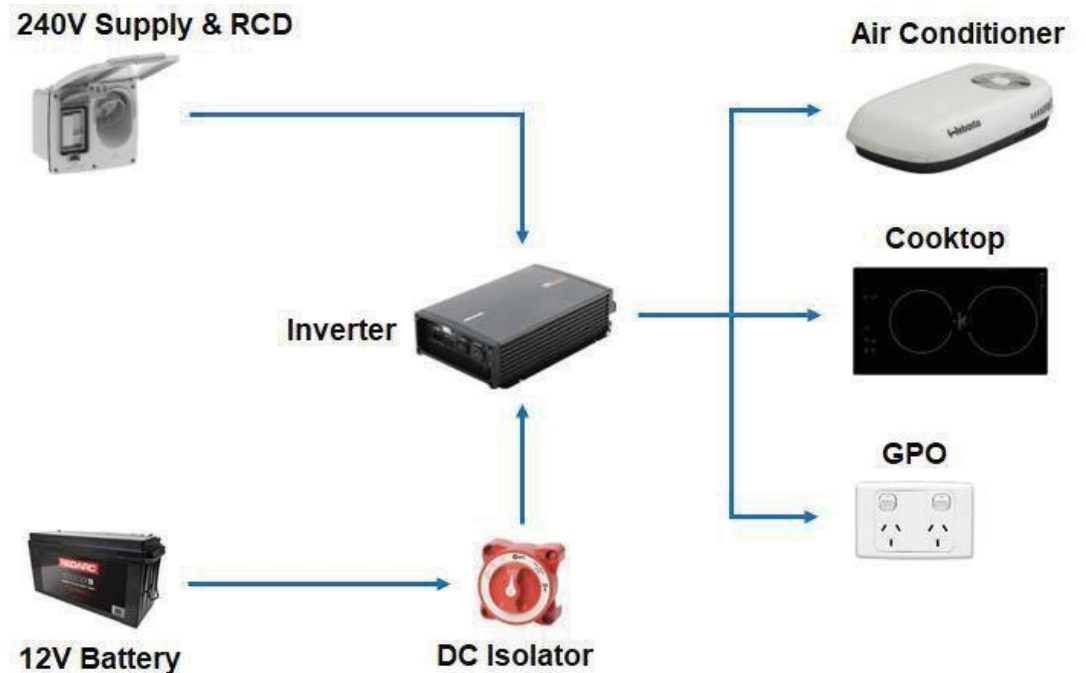

12V DC SYSTEM LINE DIAGRAM

Location: Inside the electrical service panel.

ZONE RV

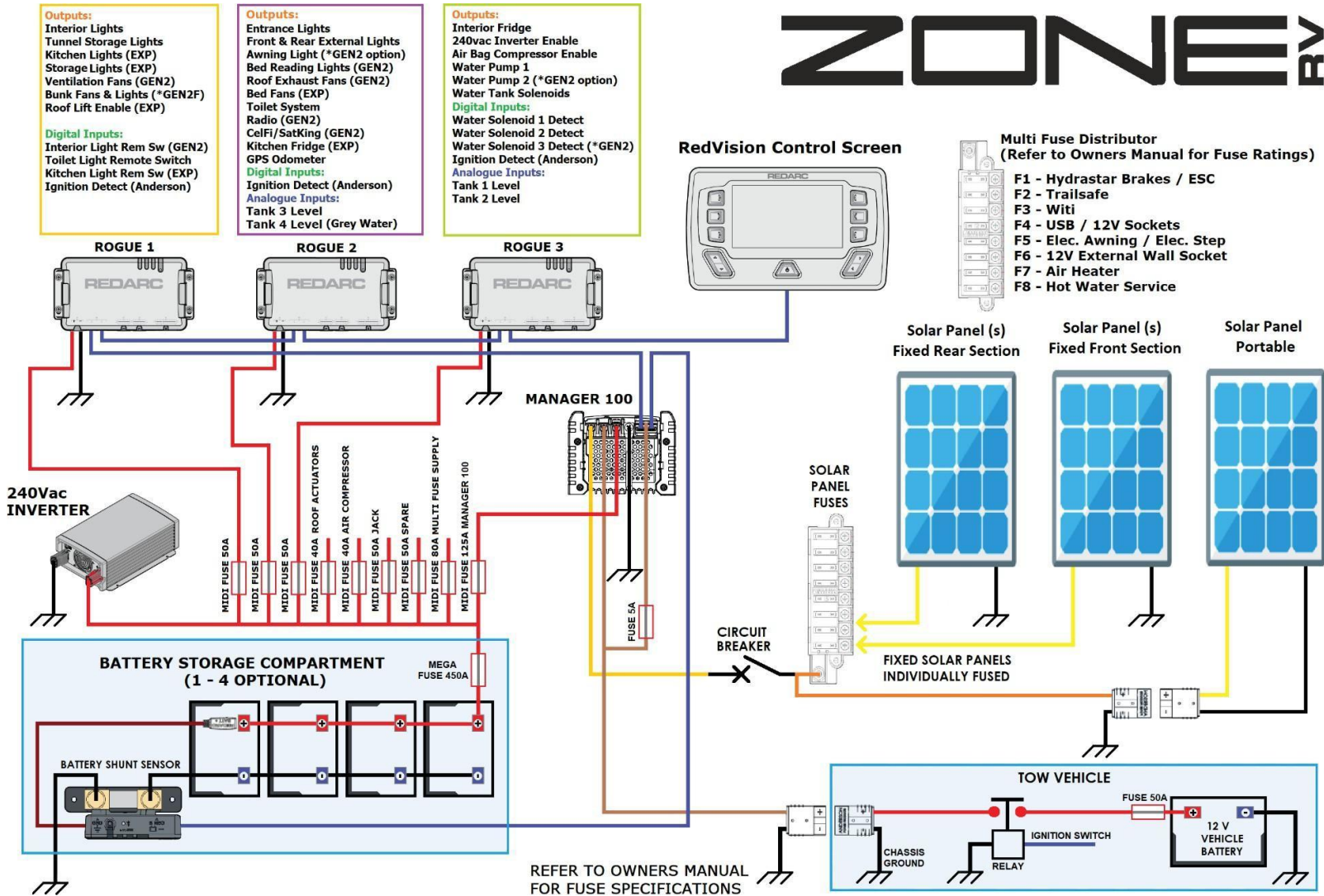

ELECTRICAL SPECIFICATIONS

FUSE RATINGS

Fuse Number	Fuse Rating	System Supply Fuses
1	125A	MANAGER ALPHA BATTERY CHARGER (MEGA Fuse)
2	80A	MULTIWAY FUSE (LOCATED AT TOP OF ELECTRICAL PANEL)
3	50A	ROGUE MODULE 1
4	40A	AIR SUSPENSION COMPRESSOR
5	50A	ROGUE MODULE 2
6	50A	ROGUE MODULE 3
7	50A	ELECTRIC JACK (OPTION)
8	40A	SPARE
9	50A	SPARE

Fuse Number	Fuse Rating	Accessory Circuit Fuses
1	40A	HYDRASTAR/ESC
2	30A	TRAILS SAFE
3	30A	WITI
4	30A	AUXILIARY USB & 12V SOCKETS
5	30A	AWNING MOTOR
6	20A	12V SOCKET (BELOW ELECTRICAL PANEL AT REAR OF FRIDGE)
7	20A	INTERIOR AIR HEATER
8	15A	HOT WATER SYSTEM

Fuse Number	Fuse Rating	Multi Solar Fuse Panel (Positions may vary)
1	15A	SOLAR PANEL
2	15A	SOLAR PANEL
3	15A	SOLAR PANEL
4	15A	SOLAR PANEL
5	15A	SOLAR PANEL
6	15A	SOLAR PANEL
7	-	SPARE
8	-	SPARE

Fuse Number	Fuse Rating	Miscellaneous Fuses
-	450A	BATTERY MEGA FUSE (located within battery storage compartment)
-	5A	GPS (located within electrical duct of power board)
-	15A	INTERIOR AIR HEATER (OEM Wiring, located under lounge)
-	1A	INTERIOR AIR HEATER (OEM Wiring Control, located under lounge)
-	20A	HOT WATER SYSTEM (OEM Wiring Heater, located under vanity)
-	1A	HOT WATER SYSTEM (OEM Wiring Control, located under vanity)
-	25A*	WITI (OEM Wiring, located in front tunnel) *Mini Auto Blade Fuse
-	30A*	WITI (OEM Wiring, located in front tunnel) *Mini Auto Blade Fuse

FUSE LOCATIONS

System Supply Fuses



Accessory Circuit Fuses

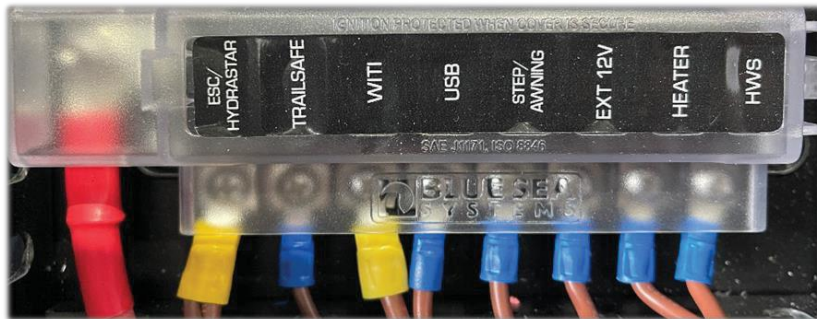

Miscellaneous Fuses CHECK PICTURES



PLUMBING SYSTEM

WATER TANK COUPLING LAYOUT – WITH SINGLE PUMP

Located on the driver's side of the caravan below the electrical service hatch are individual ports for refilling each of the three water tanks.

The couplings suit a standard 13mm garden hose connection.

Tank1 (T1/Fresh1 located nearest to the draw bar) and Tank3 (T3/Fresh2) provide water for use in the Vanity basin, Shower and Kitchen sink.

Tank2 (D/Drinking located second from the draw bar) provides water to the secondary faucet located on the kitchen tap for drinking purposes.

The Mains (M) connection provides water directly to the Vanity basin, Shower and Kitchen sink bypassing the Fresh Water pump from Tank 1 and 3.

Grey water from the Vanity basin, Shower and Kitchen sink flow into the rear tank. A hand operated valve is provided for draining the tank into an approved grey water disposal pit.

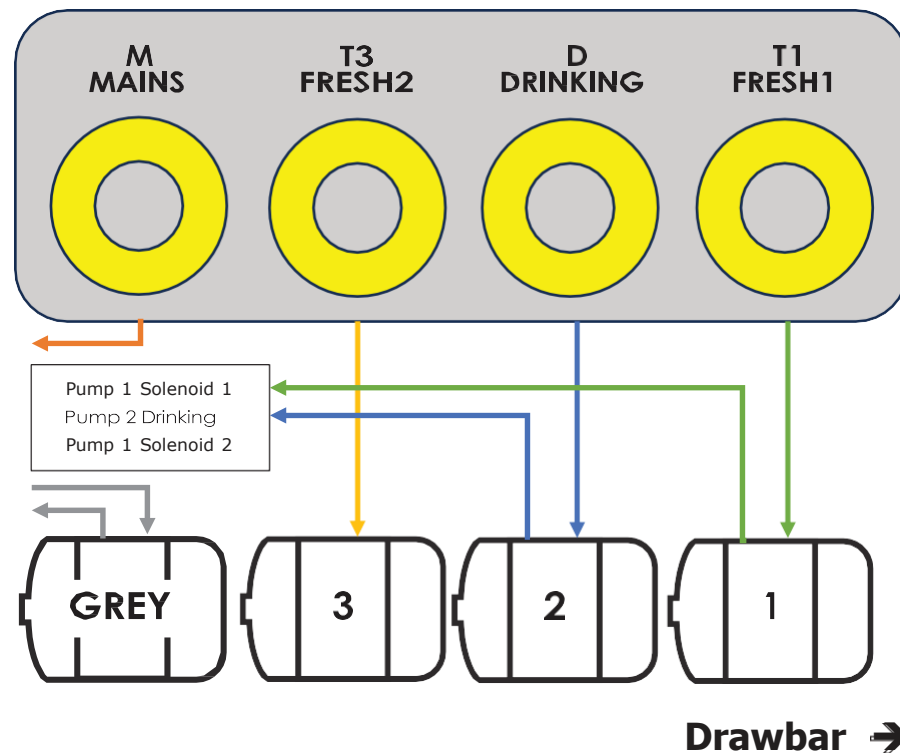

WATER TANK COUPLING LAYOUT – WITH ISOLATED DRINK PUMP

Located on the driver's side of the caravan below the electrical service hatch are individual ports for refilling each of the three water tanks.

The couplings suit a standard 13mm garden hose connection.

Tank1 (T1/Fresh1 located nearest to the draw bar) and Tank3 (T3/Fresh2) provide water for use in the Vanity basin, Shower and Kitchen sink.

Tank2 (D/Drinking located second from the draw bar) provides water to the secondary faucet located on the kitchen tap for drinking purposes.

The Mains (M) connection provides water directly to the Vanity basin, Shower and Kitchen sink bypassing the Fresh Water pump from Tank 1 and 3.

Grey water from the Vanity basin, Shower and Kitchen sink flow into the rear tank. A hand operated valve is provided for draining the tank into an approved grey water disposal pit.

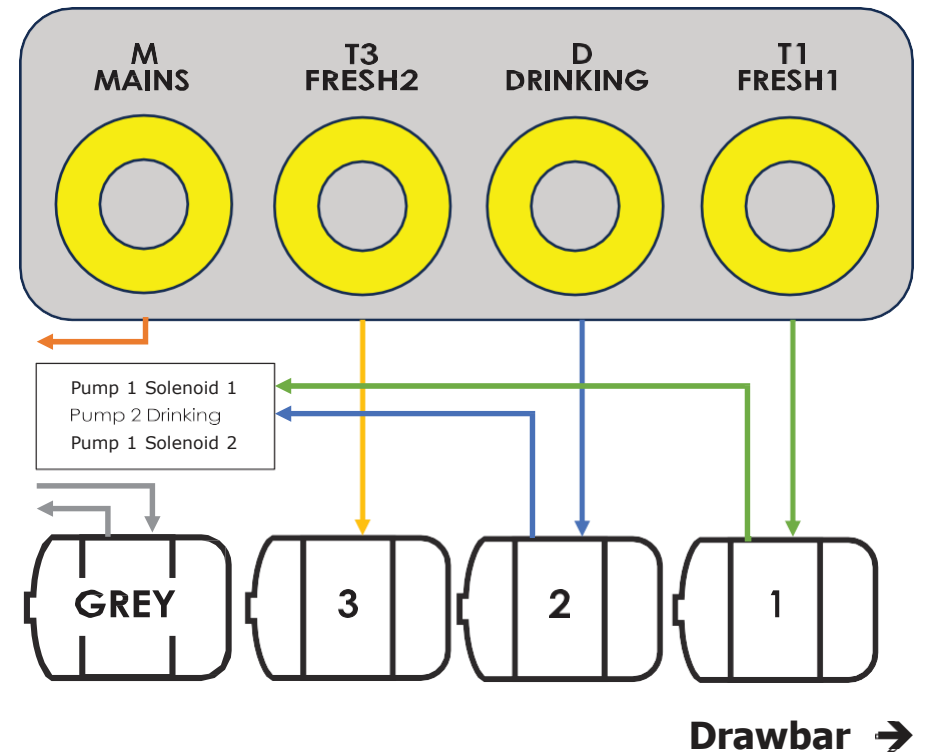

FILLING WATER TANKS

Connect a standard garden hose fitting to the coupling corresponding to the tank requiring to be refilled. Do not open the water supply tap to full pressure to allow air to escape the small tank breather tube during refilling.

Water may be expelled from the breather tube indicating the tank is completely refilled. Always refit the port covers on the water couplings.

DRAINING WATER TANKS

Bungs located on the side of each water tank to drain excess water. Unscrew the bung by hand in an anti-clockwise direction to allow the water to drain.

When replacing the bung, ensure it is done up hand tight only and do not use a tool as you may strip the bung thread. Ensure the bung seal and tank mating surfaces are clear of dirt and debris.

BUNG



DRAINING THE GREY WATER TANK

A hand operated drain valve is located on the driver's side of the caravan behind rear wheel.

Attach the grey water hose securely to the Cam Lock fitting to an approved waste pit then turn the valve to the open position.



⚠ CAUTION: Never discharge wastewater directly onto the ground.

GREY WATER BYPASS

Location: Drivers side of caravan, behind rear wheel, next to grey water

A grey water tank bypass valve is provided to discharge wastewater water via the Cam Lock fitting directly into an approved disposal connection point or pit without the need to pass the water through the caravan tank.

Attach the supplied grey water hose to the cam lock fitting and waste inlet.

Turn the Bypass valve to the Closed position.
Turn the Grey Water Outlet valve to the open position.

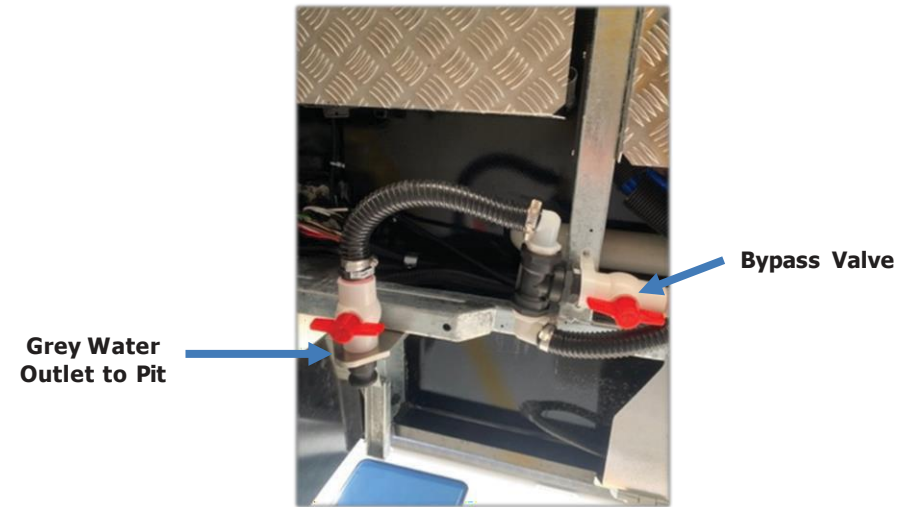
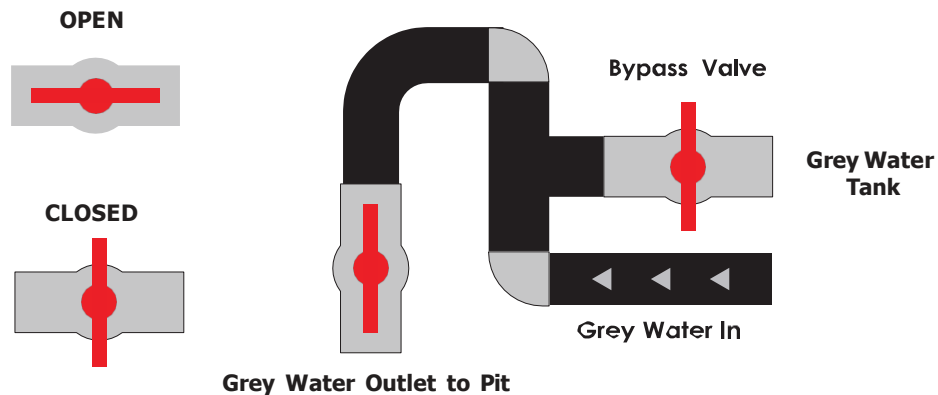

TOILET SYSTEM

Your ZONE RV caravan is fitted with an OGO Composting Toilet.

Power is continuously supplied to enable the composting process and operate the small ventilation fan to the external wall vent.

For more information, please refer to the OGO Composting Toilet manual.

REFILLING TANKS WITH PORTABLE WATER PUMP

The caravan water tanks may be refilled from a clean fresh water source using the optional portable pump.

Assemble the pump by connecting the coiled hose from the tank coupling port and the pump outlet. Place the strainer hose into a clean water supply free of sediments and debris.

With dry hands, connect the pump to the auxiliary 12V socket located within the electrical service hatch. Water will begin flowing into tanks.

Refer to the SEAFLOW Wash Down kit manual for more information.

⚠ CAUTION: The pump may only be used for a period of 10 minutes before being allowed for a period of 20 minutes. Failure to do so may result in damage occurring.

⚠ CAUTION: Never allow the pump to run dry for prolonged periods.

FEATURES & BENEFITS



WATER PUMP

Periodically check the pump filter for obstructions and cleaning if required.

Refer to pump manual for service instructions.

The water pump for tanks 1 & 2 is located under the vanity cabinet in the ensuite.

For vans with the optioned drinking water this pump is located under the kitchen sink cabinet.



⚠ CAUTION: It is recommended to turn off all water pumps when not in use. This will minimise the risk of the pump running dry and seizing if water is depleted from a tank. Periodically check the water tank levels displayed on the REDVISION™ control panel.

WATER FILTERS

The fresh water filter is located behind the inspection panel under the vanity. A secondary filter provided for the drinking water tap is located inside the cabinet in the underbed storage compartment on the driver's side of the van.

Replacement AQUAPRO AIC-K filters can be purchased from ZONE RV or resellers such as:

www.mywaterfilter.com.au



⚠ CAUTION: Ensure water pumps are turned off via the REDVISION™ control panel prior to disconnecting water tubes and relieve pressure by momentarily opening a tap associated with the filter.

PLUMBING SYSTEM DIAGRAM – SINGLE PUMP

The diagram depicts the interconnection between water tanks and outlets.

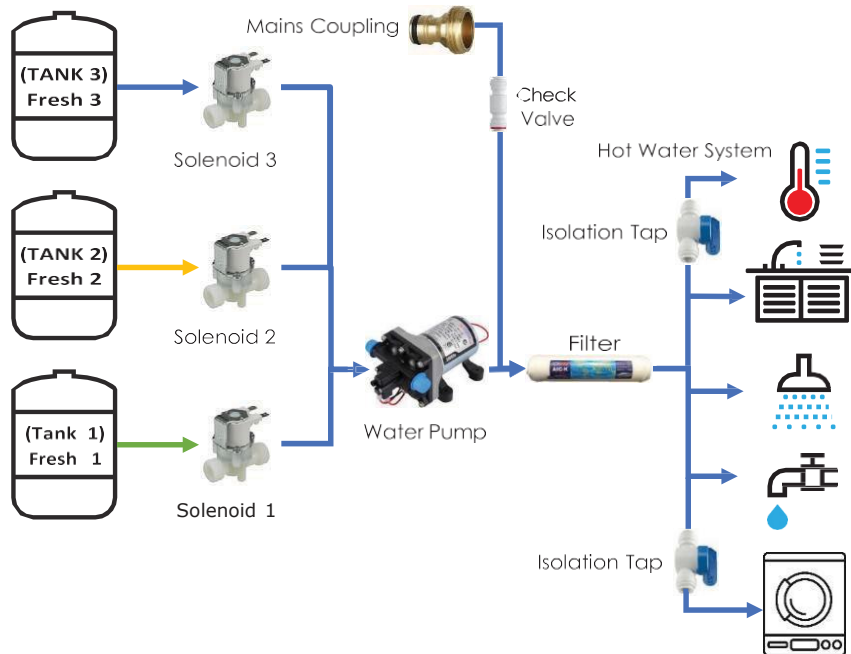

Pump Location:

Standard Layout: Inside vanity cabinet.

Family Bunk Layout: Inside cabinet under the washing machine.

A manually operated tap labelled "WASHING MACHINE" located within the vanity cupboard is used to isolate the water supply to the washing machine for maintenance purposes.

When using the washing machine, ensure the isolation tap is open and select either Fresh Water 1 or Fresh Water 2 from the REDVISION™ control panel.



PLUMBING SYSTEM DIAGRAM – TWIN PUMP

The diagram depicts the interconnection between water tanks and outlets.

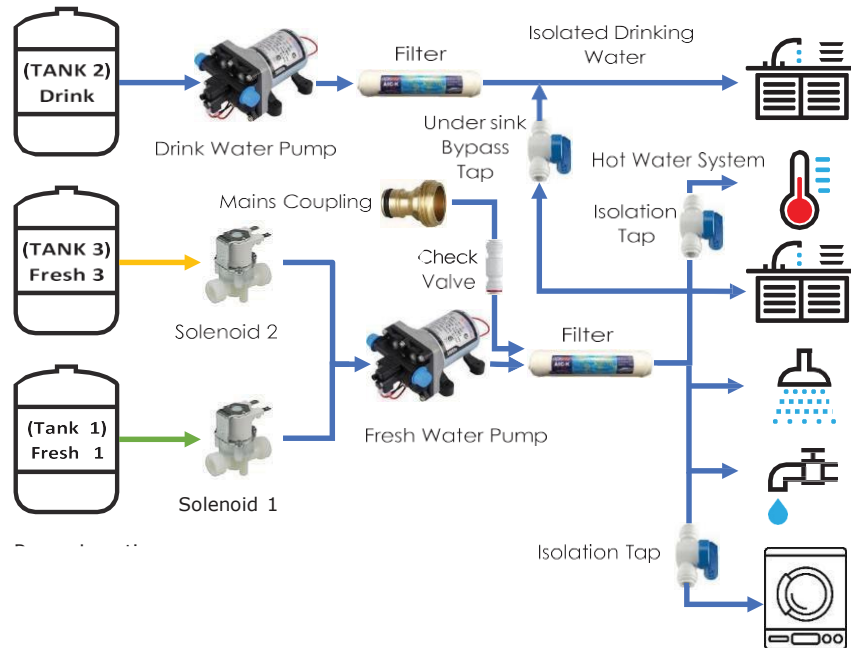

Pump Location:

Standard Layout: Inside vanity cabinet.

Family Bunk Layout: Inside cabinet under the washing machine.

Isolated Drink Pump: Under kitchen sink.

A bypass tap located under the kitchen sink allows for water to be drawn from Tank 1 or 3 for the isolated drinking water tap.



A manually operated tap labelled "WASHING MACHINE" located within the vanity cupboard is used to isolate the water supply to the washing machine for maintenance purposes.

When using the washing machine, ensure the isolation tap is open and select either Fresh Water 1 or Fresh Water 3 from the REDVISION™ control panel.



OPEN



CLOSED

HOT WATER SYSTEM

Your ZONE RV caravan is fitted with a diesel heated hot water system which is located within the vanity cabinet.

The controller is located on the vanity and is used to switch the unit on and off and to set the desired temperature.

A diesel fuel tank located at the front toolbox supplies fuel to the hot water system via a pump and filter which are fixed to the inside of the chassis rail.

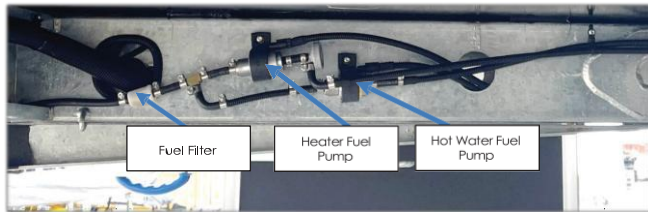

Turn the heater on approximately 20 minutes prior to use to ensure sufficient heating of the water reservoir.

Turn the hot water off via the thermostat control when it is not required to conserve fuel and minimise residual heat within and around the surrounding benchtop and cabinetry.

! NOTE: The hot water system must only be switched on or off using the WEBASTO control thermostat. Failure to do so may result in the unit malfunctioning requiring a system reset. Turn the system off using the thermostat control prior to turning off the battery master DC Isolator switch.

If the fuel tank has become completely empty, it may be necessary to reprime the fuel line.

Refer to the WEBASTO product manual for instructions on priming the fuel system.

A cold water supply isolation tap located to the left side of the hot water system is provided to shut off water from the pump when servicing or replacing the hot water system.



Periodical checks should be performed of the heating system tank fluid level and condition.

Ensure the hot water system has been turned off for a period of 24 hours before opening the filler cap atop the heater unit when performing the checks.

The system is fitted to a slide out tray for convenience. Some resistance may be felt when pulling out the tray towards to the toilet.

Ensure the hot water system filler cap is correctly seated when closing.



NOTE: It is necessary to remove the toilet system when removing the hot water system for repair or replacement.

CAUTION: During operation, avoid contact with the surface of the water unit as it can reach high temperatures which may cause contact burns.

CAUTION: Do not use if exhaust fumes are emitted into the living space.

CAUTION: Do not store temperature sensitive items such as, medicines, make up or flammable items within the hot water system cabinetry.

CAUTION: The heater buffer tank contains standard automotive glycol at a ratio of 2 parts glycol to 1 part water. Avoid contact with skin and eyes.

CAUTION: Do not open the filler cap whilst the system is hot.

ELECTRICAL JOCKEY WHEEL

Your ZONE RV caravan is fitted with an electric Jockey Wheel at the front. This system features a motorized mechanism for easy operation, allowing you to raise and lower the caravan effortlessly.

A hand crank is also supplied for manual operation, if needed.

For more information on the electric Jockey Wheel please refer to the product user manual



SUSPENSION SYSTEM

ATX AIRBAG SUSPENSION (DRUM BRAKES) - STANDARD



ATX AIRBAG SUSPENSION (DISC BRAKES) – UPGRADE



SETTING RIDE HEIGHT

To achieve the best possible ride, it is important to correctly set your suspension ride height. This allows for the correct amount of travel and for all components to be operating as designed.

As this system is designed to allow for differing loads the best way to measure and set ride height is per below.

HEIGHT SETTING METHOD

Measure the distance from lower eyelet to upper eyelet of the rebound cable mounts (as shown).

360mm from eyelet to eyelet will give you the optimised ride height for the load being carried.

For easy confirmation of ride height your ZONE RV is fitted with travel height indicators on the inside of the wheel arch. This will eliminate the need to remeasure the spacing on every adjustment.

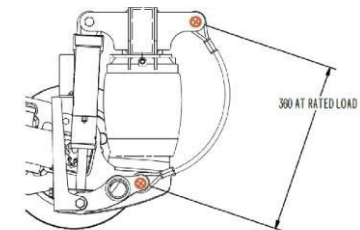

OPERATING AT NON-STANDARD HEIGHT

It is permissible to use the air springs to level the vehicle on site when stationary. This should be done with the brakes off but with the vehicle safely secured. (e.g., attached to the tow vehicle).

CARAVAN STORAGE

If storing your vehicle for long periods, the suspension can be set to below standard ride height for improved access / clearance however, during long periods of storage, it should be maintained at the normal "Travel" height where possible to protect the bump stops and air bags from compression damage. It is normal for air pressure to be lost during long term storage of your caravan causing the suspension height to lower.

"GET YOU HOME" MODE (EMERGENCIES ONLY)

In the event of air loss, it is possible to run the caravan on the bump stops. The "get you home" feature of the suspension has been successfully used on normal roads.

Extreme care and very slow speeds are required if running with airbags deflated. Off-road conditions especially can cause damage to airbags and drawbar mounting brackets. It may be advisable in these circumstances to lower tyre pressures to provide additional cushioning to road bumps.

! **NOTE:** Warranty does not apply under these conditions.

AIRBAGS

TRAVEL HEIGHT

The critical function for the correct traveling arrangement is the HEIGHT of the caravan, NOT the airbag pressure. The following image shows the correct way to measure height for travel from the top of the bump stop to the bottom of the chassis rails.

The normal operating PSI range is 50-90. Anything more than this can show overloading in your caravan or incorrect travel height. Traveling with the airbags higher or lower than these PSI settings can result in damage of your ZONE RV and may not be covered under warranty.

! NOTE: If the compressor has been off for some time, it will need a few minutes to fill the air tank before you can pump the airbags up.

! NOTE: Your airbag pressure will likely be different from side to side when setting this up and that is normal.

! NOTE: Airbag operating pressure must never exceed 100psi.

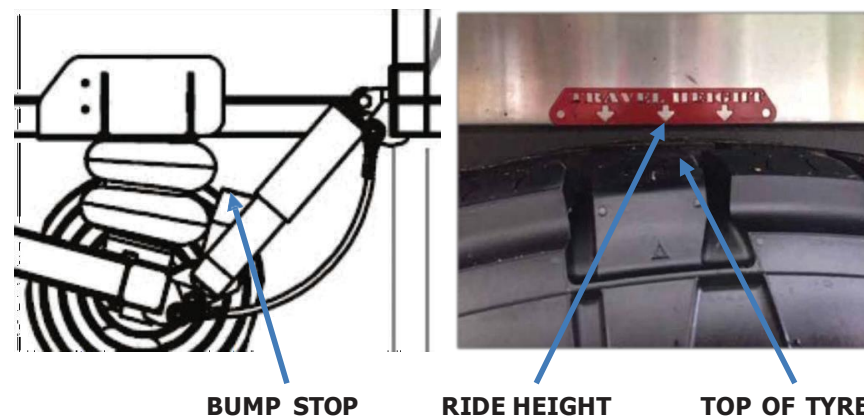

AIR BAG CONTROL PANEL - MANUAL LEVELLING SYSTEM

Turn on the Air Compressor to ensure ample air pressure is available for the airbag system.

Monitor the AIR PRESSURE LEVEL GAUGE while performing height adjustments.

Levelling the caravan at campgrounds is carried out by toggling the MANUAL LEVELLING SWITCHES to raise or lower either side of the caravan.

Return the airbags to travel height by operating the MANUAL LEVELLING SWITCHES until the desired suspension height is reached.

Refer to the ATX SUSPENSION section and the manufactures manual.

! Note: Airbags may only be used to level the caravan side to side. Fore and aft levelling is achieved using the jack mounted on the drawbar of the caravan.

! Note: It is good practice to periodically drain moisture from the air tank. A manually operate valve is located on the tank. Turn the Air Compressor OFF during draining.

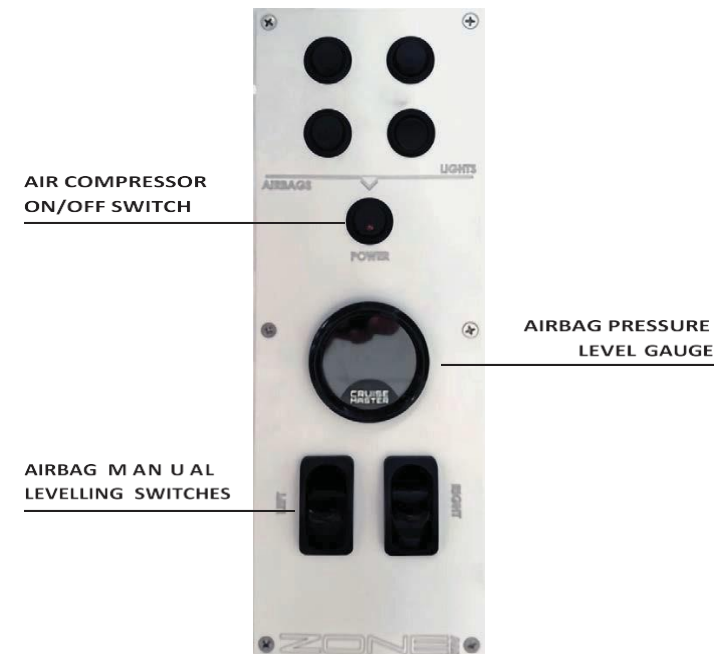

AIR BAG CONTROL PANEL - AUTOMATIC LEVELLING SYSTEM

Turn on the Air Compressor to ensure ample air pressure is available for the airbag system.

Monitor the pressure gauge while performing height adjustments.

Levelling the caravan at campgrounds is carried out by toggling both AUTO/MANUAL height control switches to MANUAL. Then operate the airbag MANUAL LEVELLING switches to raise or lower either side of the caravan.

Return the airbags to travel height before departure to the preset travel heights by setting both AUTO/MANUAL height control switches to AUTO.

Switch back to MANUAL height control once the system has stopped adjusting the suspension heights. Refer to the ATX SUSPENSION section and the manufactures manual.

! Note: Airbags may only be used to level the caravan side to side. Fore and aft levelling is achieved using the jack mounted on the drawbar of the caravan.

! Note: It is good practice to periodically drain moisture from the air tank by operating the TANK DRAIN SWITCH. Turn the Air Compressor OFF during draining.

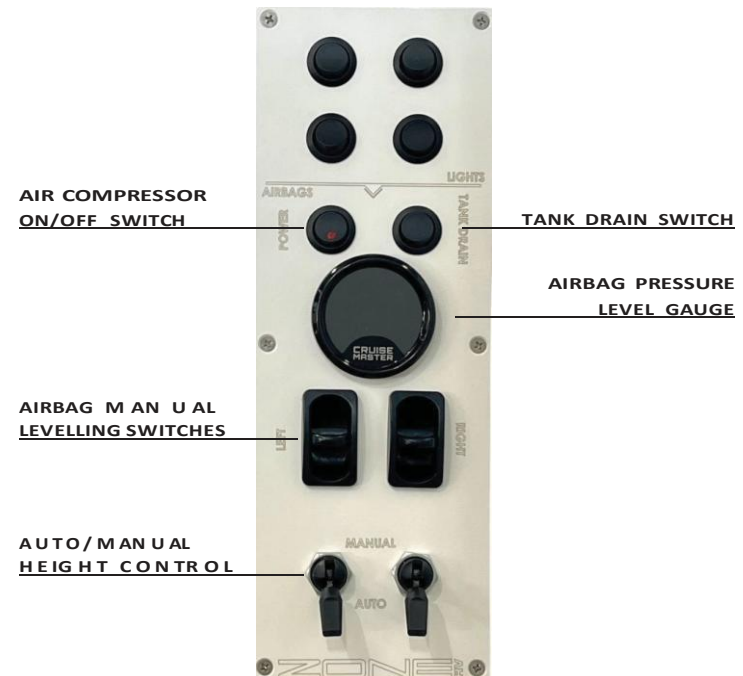

MAINTENANCE

SAFE JACKING

- Park the caravan on firm and level ground.
- Chock the tyres on the opposite side securely so that no forward or rearward movement is possible.
- Jack up the caravan directly under the shock absorber at the lowest point of the swing arm as shown below.
- Secure the caravan on jack stands of adequate capacity front and rear.



ATX SUSPENSION JACKING POINTS

! Note: It is recommended to have a qualified mechanic perform wheel bearing servicing.

DRUM BRAKE ADJUSTMENT

The electric brakes fitted to your ZONE RV are self-adjusting but may require manual adjustment from time to time.

To do this, jack one wheel up at a time on a level concrete floor. Refer to section SAFE JACKING. Chock the opposite side wheels and the jockey wheel front and back then slowly release the hand brake.

Ensure the caravan is stable and safe before commencing work. It is good practice to attach to the tow vehicle to provide additional safeguard against movement of the caravan.

If installed remove the two plastic caps on the lower section of the backing plate, with a flat bladed screwdriver.

Insert adjusting tool or similar flat blade screwdriver approximately 2 cm inside the slot to engage with the adjuster toothed wheel.

Rotate the adjuster as shown in the diagram below until the brakes begin to grab on the brake drums then back them off exactly 10 notches. The wheel should rotate freely.

Repeat the process on for all wheels.

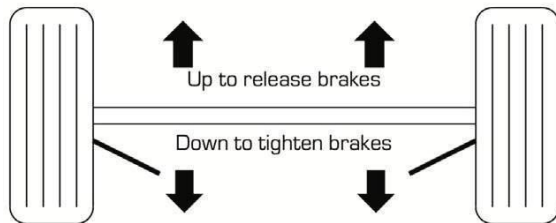

Insert screwdriver into slot, engage into adjuster and lever downwards to adjust up brakes or upwards to release brakes.

WHEEL HUBS

Always check the hub temperatures at least twice a day when traveling. They should be warm to touch. If one side is consistently hotter than the other, have them checked immediately by a Mechanic or Service Agent.

When traveling on dirt roads, check hub temperatures every time you stop or at least every hour.

When traveling on dirt roads check wheel nuts every morning before departure without fail, on both tow vehicle and caravan.

If the brakes or hubs become excessively noisy, hot or are grabbing, have them serviced by a motor mechanic or service agent.

! NOTE: Please refer to the CRUISEMASTER manual and website for specific maintenance requirements relating to suspension components.

Wheel Hub removal instructions:

- Undo the wheel nuts and remove the wheel.
- Pry off the dust cap using a flat bladed screwdriver.
- Straighten out the split pin that holds the bearing nut and remove it. Remove the bearing nut and washer.
- Gently pull the brake drum forward while cupping the hub opening with your hand to keep the front bearing from falling to the ground. The outer race stays in the drum, while the inner race and roller bearings come out as an assembled unit.
- Place the front bearing, bearing nut and the bearing washer in a clean container so as not to contaminate.

! NOTE: It is recommended to use a new split pin for reassembly.

! NOTE: It is recommended that you have a qualified mechanic perform bearing servicing.

CHECKPOINTS AFTER A SHORT TIME ON THE DIRT

Generally, 30min intervals are good to check your caravan to see if anything has worked loose.

This is a good practice until you are confident that all fasteners have bedded in and holding. During checks, also ensure there are no areas showing signs of dust ingress.

DUST INGRESS

Although your caravan has been fully sealed during production, there is a small chance theglues and sealants may have moved allowing dust ingress. It is always good practice to travel with a tube of silicon sealant to perform minor spot resealing.

Periodically check that your external hatches are sealing correctly by evidence of dust ingress. It may be necessary to adjust the locking levers from time to time.

BEACH USE

After driving on the beach or camping near salt air, wash your caravan thoroughly and apply a liberal coating of Inox or WD40 to all steel, stainless steel and aluminium surfaces. Allow it to soak in for 24hrs wiping off excess residue or washing at a car wash. Periodically check that your external hatches are sealing correctly by evidence of dust ingress. It may be necessary to adjust the locking levers from time to time.

CARAVAN WELDING

! NOTE: Please contact ZONE RV prior to commencing any welding works on the chassis as doing so may void your chassis warranty.

! NOTE: Prior to commencing welding, the batteries and all caravan electrical harnesses earth connections to the chassis **MUST** be completely disconnected. Failure to do so may result in damage and or fire of the wiring harnesses.

- Disconnect the battery negative cable at the battery storage compartment and insulate bare cable lugs with PVC electrical tape.
- Earthing points may be found in the following locations on the inside of the chassis rails.
- Forward of front axle inside chassis rail – Passenger Side.
- Rear of back axle inside chassis rail – Drivers Side.
- Ensure that all earth points are reconnected prior to attaching the storage battery cable and 240V mains power.

Care must be taken to reinstate the corrosion resistance where welding has taken place.

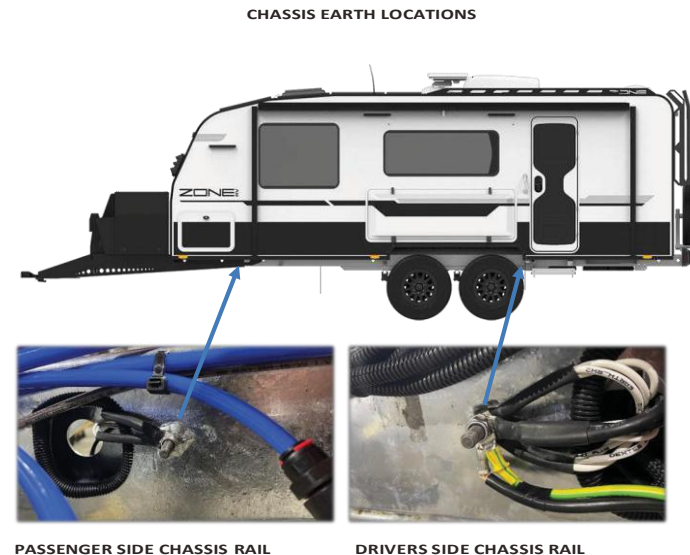

DRAWER FRONT PANEL ADJUSTMENT

Location: Behind plastic side covers.

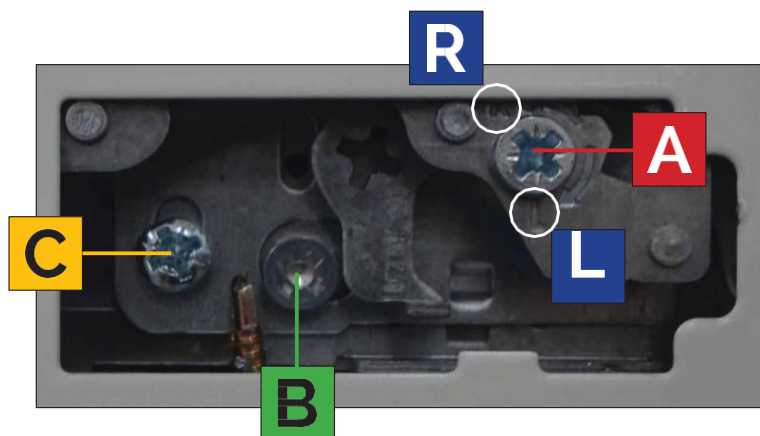

MOVING PANELS TO THE LEFT - L

1. Open drawer
2. Remove covers located on either side of side panels
3. Insert tool into position **A**
4. Turn towards **L**
5. Adjust panel to the left

MOVING PANELS TO THE RIGHT - R

1. Open drawer
2. Remove covers located on either side of side panels
3. Insert tool into position **A**
4. Turn towards **R**
5. Adjust panel to the right

MOVING PANELS UPWARDS - U

1. Open drawer
2. Remove covers located on either side of side panel.
3. Loosen locking screw **C**
4. Insert tool into position **B**
5. Turn anti clockwise on left side and clockwise on right side

MOVING PANELS DOWNWARDS - D

1. Open drawer
2. Remove covers located on either side of side panel
3. Loosen Locking Screw **C**
4. Insert tool into position **B**
5. Turn clockwise on left side and anti-clockwise on right side



PREPARING FOR OFF-ROAD

Always perform visual inspections of the caravan before, during and after OFF-ROAD driving.

Although great care is taken of selecting the correct fastenings methods, these are not infallible to the rigours of off-road driving.

The following is a list of things to check before hitting the dirt:

- Ensure cupboard fastenings are tight.
- Check all draw latch fasteners with a Philips head screwdriver.
- Check all fixtures for appliances and components (water pumps, inverter, cooktops etc).
- Check all cupboard door hinge mounts are tight. Doors may open unexpectedly due to loose fasteners and latches.
- Check all draws and doors are latched correctly.

- Check fasteners of drawbar components are tight.
- Check toolbox bolts and gas bottle holders are tight and the gas supply tap is isolated and gas port cover is securely attached.
- Check the STARLINK sidewall port cover is screwed on.
- Make sure your Anderson plug is securely connected to the back of the tow vehicle. Cable tie the lead together with the trailer plug lead to minimise the chance of damage should it become disconnected.
- Check all hatches are closed tight and adjust hatch latches as required by applying moderate force to it to tighten the hatch closed.
- Walk around the caravan and visually inspect to see if there is anything unusual such as loose components or any areas showing signs of damage.
- Check your tyre pressures and suspension height and adjust to suit the towing conditions.



DRIVING RECOMMENDATIONS

THIS IS A GUIDE ONLY

Some of the conditions that you may encounter during your travels may cause damage to your caravan if you do not take early protective measures.

ZONE RV has the following recommendations for some of these conditions, (note these do not account for traffic or weather conditions). Ensure that the vehicle is appropriately loaded to maintain stability while towing.

STANDARD COLD TYRE PRESSURES - 110km/h SPEED LIMIT)

TYRE PLACARD				
RECOMMENDED COLD INFLATION PRESSURE				
MODEL	TYRE SIZE	UP TO 3000KG kPa(Pa)	MAX LOAD ATM 3500KG kPa(Pa)	MAX LOAD ATM 4000KG kPa(Pa)
ZPP ZSP	265/70 R17 121/118S	310 (45)	365 (53)	420 (61)
ZSPF EXPEDITION	285/65 R18 125/122S	275 (40)	325 (47)	365 (53)

DUSTY ROAD TYRE PRESSURE - 35 PSI (100km/h SPEED LIMIT)



LIGHTLY CORRUGATED

28 PSI
(80 - 100km/h Speed Limit)



MODERATE CORRUGATIONS

23 PSI
(80km/h Speed Limit)



LARGE CORRUGATIONS

18 PSI
(60km/h Recommended Minimum Speed where possible, Maximum Speed 80km/h)

SAND DRIVING

- Reduce speed and reduce all tyre pressures on both the van and vehicle to 18psi or less.
- Try to drive on the harder sand. Maintain the momentum of your vehicle while negotiating soft sand and stay in the wheel ruts as they are usually more compacted than the undriven sand.
- If your vehicle allows, select low range auto for beach access and high range 4WD for hard sand driving. It is advisable to turn the brake controller off as sudden stopping can bog the trailer.

WATER CROSSING

- Stop for a period of time to allow the hubs and bearings to cool before making a water crossing. This may prevent ingress of water through the wheel bearing seals.
- After making water crossing, apply the brakes once on the track until braking is normal, or use the brake controller to apply the trailer brakes to dry out the linings while driving at a low to moderate speed.
- Always check and regrease bearings during maintenance checks after water crossings.



RECOVERY POINTS

Your ZONE RV Caravan is fitted with two load rated recovery points at the rear of the chassis to assist in recovery of the caravan in the event that it becomes stuck and cannot be recovered by towing it forward.

These points should only be used with suitably rated recovery equipment shackles and an equaliser strap.

Avoid using snatch straps or kinetic ropes when recovering your caravan.

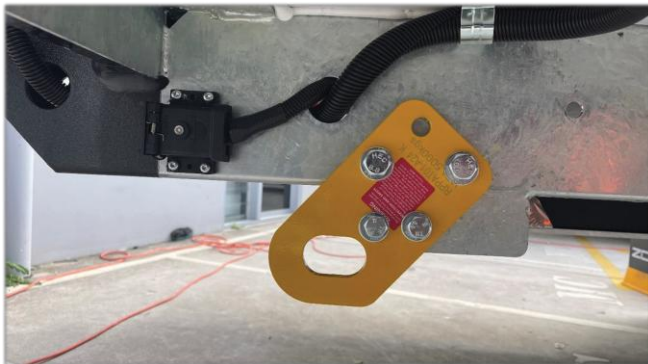

BIKE CARRIER (OPTIONAL)

Your ZONE RV Caravan may include provision to install a bike carrier attached to the rear bar.

This socket is only intended for use with the iSi-442-400/40 - Extreme Duty Compact Beam carrier with a maximum bike load of 37kgs.



DEPARTURE CHECKLIST

INTERNAL CHECK

- Turn off water heater/ diesel heater/ water pumps.
- Lock all windows in the closed position.
- Open window blinds to "Travel" position.
- Remove TV from Wall mount and place in a secure position.
- Lower table into the "Travel" position.
- Close roof hatches and exhaust fan vent covers including shower fan.
- Ensure that fridge door is latched.
- Ensure that the ensuite door is latched in "Travel" position.
- Stow shower head on the floor wrapped in a towel or in bathmat.
- Switch Redarc REDVISION Panel to "Touring" mode.
- Press and hold the Master Power key on the REDVISION™ control panel to place the system into standby mode. (Battery charging will still occur, power will remain available for the fridge and it's control panel.)

EXTERNAL CHECK

- Turn OFF Gas bottle valves.
- Disconnect gas appliances from the external service port, turn off the yellow isolation tap and attach the gas port cap.
- Close the external kitchen and secure all catches firmly.
- Fold down aerial into travel position (TV, Mobile Phone Booster etc).
- Fully retract awning and secure latches and tighten black thumb wheels.
- Set stabiliser legs to "Travel" position.
- Set entry step to "Travel" position.
- Disconnect mains water supply hose and grey water waste hose.
- Disconnect mains electricity cord.
- Set airbags to travel height.
- Ensure all hatches and glass entry door have been closed and locked correctly.

SAFETY CHECK

- Check safety chains & brake-safe lanyard are connected.
- Check trailer & Anderson plugs are connected.
- Check all lights & indicators.
- Check caravan coupling is secured to vehicle & cover cap is on.
- Check jack is set in "Travel" position.
- Check handbrake is fully released.
- Check that suspension is set to travel height.

WHEEL NUTS/LUGS & BEARINGS

Wheel nut torque must be checked prior to each trip and following the first 100km of operation following a wheel change or removal to ensure that it is within specification.

Failure to do so could result in an accident or injury. Tightening sequence is as per the following image.

Recommended torque = 209Nm/ 154 f t-lbs

! NOTE: A calibrated torque wrench should be used to ensure accuracy. Impact rattle guns are not recommended for achieving correct wheel nut torque.

! NOTE: It is the tow vehicle driver's responsibility to check the wheel nuts prior to each trip.

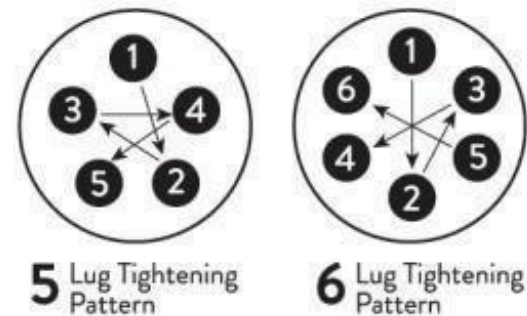

! NOTE: It is advised to check & re-grease the wheel bearings after immersing the axles in water. If you have done a large trip that includes traversing water crossings a wheel bearing service is required.

VIN/COMPLIANCE PLATE, TARE & ATM

The vehicle VIN number is welded or riveted to the top of the drawbar adjacent the hitch.



The ATM maximum load capacity identity plate can be found on the inside of the drawbar.

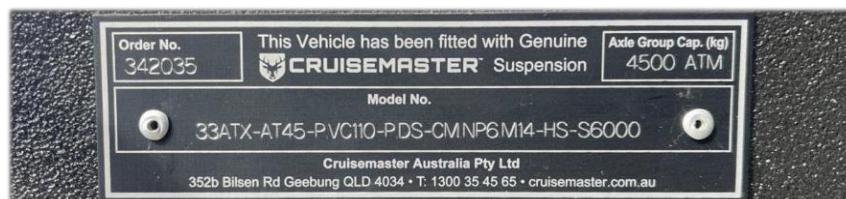

The tyre placard is located within the tunnel boot and includes information about the tyres load rating, sizes and pressures for normal road use.

TYRE PLACARD				
RECOMMENDED COLD INFLATION PRESSURE				
MODEL	TYRE SIZE	UP TO 3000KG kPa(PSI)	MAX LOAD ATM 3500KG kPa(PSI)	MAX LOAD ATM 4000KG kPa(PSI)
ZPP	265/70 R17	310 (45)	365 (53)	420 (61)
ZSP	121/118S			
ZSPF	285/65 R18	275 (40)	325 (47)	365 (53)
EXPEDITION	125/122S			

⚠ CAUTION: EXCEEDING THE CARAVAN'S ATM & BALL WEIGHT IS ILLEGAL AND DOING SO WILL VOID YOUR WARRANTY AND MOST LIKELY INSURANCE.

ZONE RV AFTER SALES SERVICE CONTACT

85 Quanda Road
Coolum Beach
QLD 4573
(07) 5471 6410
Knowledge Base (zonerv.com.au)

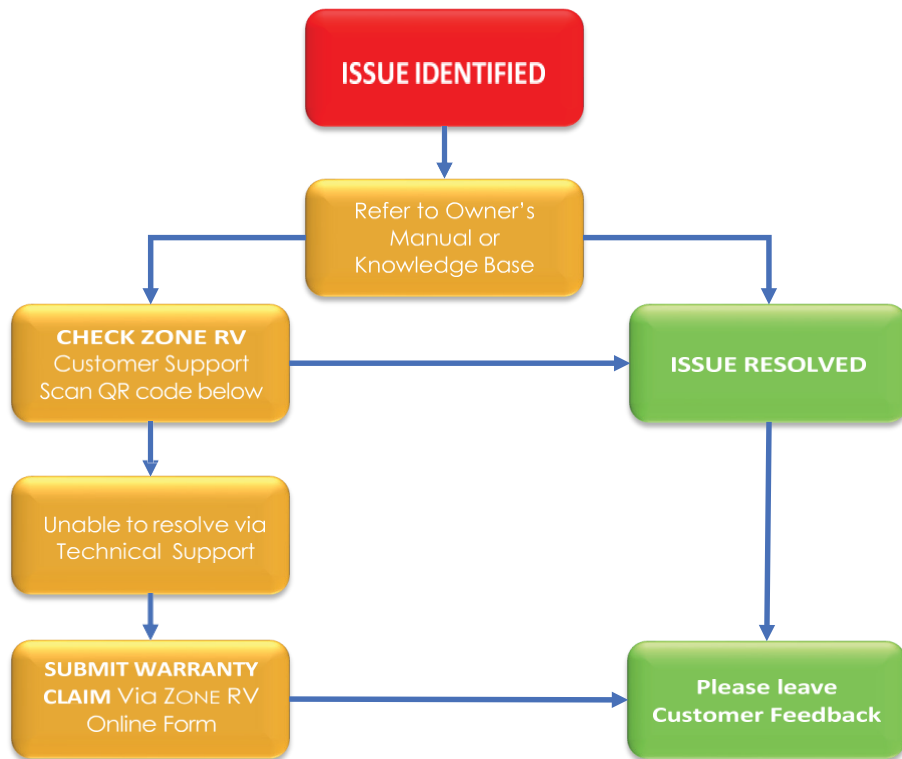

DISCLAIMER

This manual is provided for general information to be used as a guide only.

While every care has been taken to ensure the accuracy and coverage of content within this manual, omissions and variations such as text descriptions, images and specifications may vary due to manufacturing processes, change of supplier components and legislative requirements.

Check the ZONE RV webpage for updates. Always confer with manufacturers latest manuals and knowledge articles.

The owner and tow vehicle driver must make use and rely on their own experience for assessment of situations to determine the suitability and usefulness of this information.

Accordingly, ZONE RV makes no representations, warranties, or guaranties, either expressed or implied, regarding the accuracy and suitability of usefulness of this information.

ZONE RV accepts no liability for any loss, damage, claim, or expense incurred by caravan owner, tow vehicle driver or any third party arising from the use of or reliance on the information provided within this manual.



AMENDMENTS

PAGE	SECTION	CHANGE NOTES	DATE
		Edition 1 released	24/05/24

OWNERS NOTES